

TURBINE STARTING AIRCRAFT BATTERY

TSO AUTHORIZED

RG-325 Specifications

Voltage	24 Volts
Rated Capacity C ₁	25 AH
Maximum Weight	52.0 LB / 23.6 KG

Specifications are subject to change without notice

**IEC Rated for Peak Power (IPP)
 & 15 Second Power Rating (IPR)**

IPP	IPR	IPP	IPR	IPP	IPR
At 23° C (74° F)		At -18° C (0° F)		At -30° C (-22° F)	
1000 A	650 A	750 A	600 A	550 A	450 A

Rated in accordance with International Standard 60952-1

ISO 9001 + AS9100

The data/information contained herein has been reviewed & approved for general release on the basis that this document contains no export controlled information.

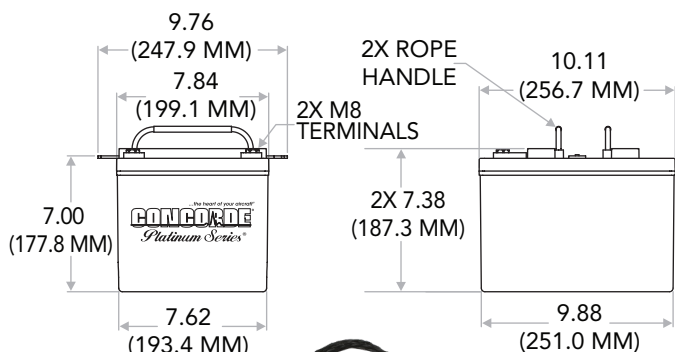

Concorde's superior Platinum Series® batteries have been proven reliable, durable and safe in turbine aircraft applications for more than two decades. Concorde's valve regulated sealed recombinant gas (RG®) Turbine Starting aircraft batteries are constructed with advanced lead acid, absorbed glass mat (AGM) technology.

- Dual Purpose – Emergency or main starting
- Corrosion Free Terminals – Silicon bronze alloy M8 terminals
- Durable – Polypropylene container
- Emergency Power – Reliable essential power in the event of a generator failure
- Factory Tested – Assures airworthiness & installation readiness
- Low impedance design – Unique design features reduce internal resistance
- Maintenance Free – No water replenishment is required – ever
- Proprietary PolyGuard® Separators - Added protection against shock & vibration
- Proven Technology – Dependable, durable and safe
- Safe – No threat of thermal runaway & no deep cycling
- Starting Power – Superior starting power in hot & cold climates
- Transport – Ship Hazmat Exempt whether by land, sea or air
- Worldwide – Available through a professional network of worldwide distributors

Concorde designs and manufactures over 90 models of Original Equipment and direct replacement batteries for fixed wing and rotary aircraft and has a reputation for designing application specific solutions. Concorde batteries are installed as Original Equipment by the majority of aircraft manufacturers and adopted by military aircraft operators worldwide.

Manufacturing certified aircraft batteries for over 40 years: Military, TSO, FAA-PMA , OEM

RG-325