

Advancing Aviation Technology

2024 Product Catalogue

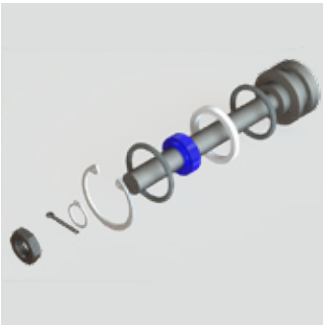

Engineer | Design | Manufacture

www.MarshBrothersAviation.com

Contents

Product Kits by Aircraft

Baron

Brake Master Cylinder Upgrade/Repair Kit	6
Fuel Cap Washers	8
MLG Door Hinge Bushing and Installation Kits	10
NLG Door Hinge Bushing Kit	12
Spinner Washers	14

Bonanza

Brake Master Cylinder Upgrade/Repair Kit	18
Fuel Cap Washers	20
MLG Door Hinge Bushing and Installation Kits	22
NLG Door Hinge Bushing Kit	24
Spinner Washers	26

King Air

Brake Master Cylinder Upgrade/Repair Kit	30
NLG Door Hinge Bushing Kit	32
Fuel Cap Washers	34
Spinner Washers	36

Marsh Brothers Aviation, a Thomson-Gordon Group company with over 110 years of history, is a family-owned business that develops and manufactures high performance specialty bearings, seals and engineered mechanical components for the global aviation industry. These products are manufactured from Marsh Brothers' proprietary polymers and engineered to offer a variety of benefits including improved durability and lighter weight. Marsh Brothers is dedicated to designing and producing solutions that improve aircraft reliability and maintainability, while reducing its environmental impact.

Contact Us:

Address: 3225 Mainway, Burlington, ON L7M 1A6 Canada
Phone: 1-800-263-6242
Email: info@MarshBrothersAviation.com
Website: www.MarshBrothersAviation.com

Aerostar

Landing Gear

Brake Bushing Kit	40
MLG Upper and Lower Bumper Kits	42
MLG Oleo Kit	44
MLG Trunnion Kit	46
Wiebel NLG Bushing Kit	48
Wiebel NLG Oleo Kit	50
Wiebel NLG Torque Link Kit	52

Interior

Control Knob Kit	54
Fuel Selector Knobs	56
Landing Gear Handle Knob Kit	58
Seat Roller Repair Bushing and Sleeve Kit	60
Seat Stopper	62
Throttle Knob Kit	64

Other

Fuel Cap Washers	66
Hydraulic Accumulator	68
Spinner Washers	70
Cleveland Brake Master Cylinder Upgrade/Repair Kit	72
Engine Cowl Anti-Chafing Liner	74
Turbo Cross-Shaft Bearing Block Kit	76

Mooney

Fuel Cap Washers	80
Spinner Washers	82
Cleveland Brake Master Cylinder Upgrade/Repair Kit	84

Cirrus

Cleveland Brake Master Cylinder Upgrade/Repair Kit	88
Spinner Washers	90

Cessna

Fuel Cap Washers	94
Spinner Washers	96

Terms & Conditions

General Terms & Conditions of Sale	98
------------------------------------	----



Baron Products Overview

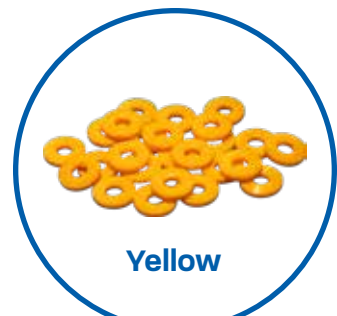

Spinner Washers

Yellow



Grey



Clear



Parker Aerospace /
Shaw Aero AeroTough®
Fuel Cap Washers

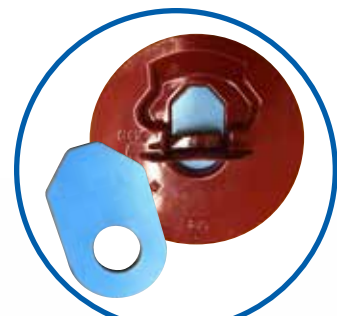

Parker Aerospace /
Shaw Aero AeroTough®
Fuel Cap Washers



Gabb AeroTough®
Fuel Cap Washers

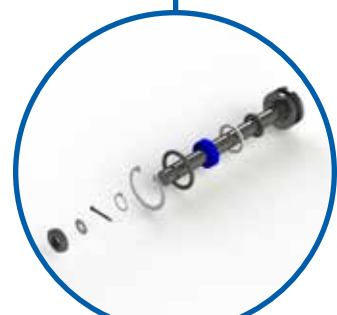

Brake Master Cylinder
Upgrade/Repair Kit



NLG Door Hinge
Busing Kit



MLG Door Hinge
Installation Kit

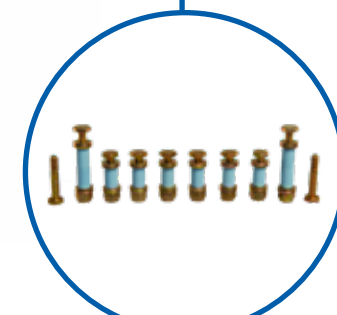

MLG Door
Hinge Kit

Brake Master Cylinder Upgrade/Repair Kit

FAA and TCCA Approved

Improve Your Aircraft While Reducing Your Maintenance Costs

Overview

The OEM brake master cylinders use a rubber lip seal as the piston rod seal and the rod runs in a bronze/aluminum gland. The Marsh Brothers Aviation Brake Master Cylinder Upgrade/Repair Kit includes all the internal hardware to upgrade the cylinder and replace all elements that could leak or deteriorate. The most important element is the V-ring seal made from MBA's seal polymer which replaces the stock seal made from molded rubber.

Instead of buying a brand new master cylinder assembly, rebuild the one you have to better-than-new condition.

Benefits

- ☑ The MBA dynamic rod seal is more flexible than rubber under cold conditions and less prone to leak when the aircraft is not in a heated hangar in winter.
- ☑ There's nothing else to buy; everything you need to rebuild the cylinder is contained in the kit.
- ☑ Rebuild your existing cylinder and save money in the process.
- ☑ The MBA dynamic seal is more wear-resistant than rubber.



Note: The Piston is not included in this kit. Refer to the Contents section on next page.

Approved Aircraft	Product Number	Price	Approved Models
Beechcraft® Baron	M-03-1001-1	\$126.00 USD	See next page
Beechcraft® Baron	M-03-1001-3	\$126.00 USD	See next page

Prices subject to change without notice.

Approvals

TCCA STC No. SA21-5, FAA STC No. SA04634NY

Approved Models

Baron Models

E55	E55A	D55	D55A	56TC	58	58A	58P	58PA
58TC	58TCA	G58	95	95-55	95-A55	95-B55	95-B55A	95-B55B
95-C55	95-C55A	A56TC	B95	B95A	D95A	E95		

Applicability

Product Number	OEM P/N 96-380034-()			
	-25	-23		
M-03-1001-1	X			
M-03-1000-3		X		

Contents

Item#	MBA Part #	Description	QTY	OEM Cross Reference Part #
1	AN316-5R	Nut Rod End Jam	1	AN316-5R
2	MS16625-1100	Internal Retaining Ring	1	MS16625-1100
3	MBA-03-10000-1	Piston Rod Gland Seal	1	A57G401 / AN6227B6
4	MS28775-117	O-Ring (Static Gland)	1	AN6227B11
5	MS28775-111	O-Ring (Piston Head)	1	AN6227B9
6	MS28774-013	Back-Up Ring (Piston Head)	1	N/A
7	MS24665-132	Cotter Pin	1	AN380C2-2
8	MS16624-1037	External Retaining Ring	1	N/A

Note: This kit does not fit brake master cylinders manufactured by Gerdes or Paramount.

Caution: Thorseal® is made from Marsh Brothers' proprietary material known as AeroLas™-Flex which is not compatible with phosphate ester hydraulic fluid, commercially known as Skydrol. Exposure to this fluid contamination will damage the seals.

AeroTough® GF Fuel Cap Washers

FAA, TCCA and EASA Approved

Avoid the hassle of difficult to open and close fuel caps.
An easier way.

Overview

Installing Marsh Brothers' Non-Metallic AeroTough® GF (Grease-Free) Fuel Cap Washers will ensure your fuel cap remains safe and functional, making opening and closing much easier. The washer which is CNC machined to exact shape is made from a polymer produced by Marsh Brothers' parent company and is not available commercially from any other source. It has extraordinary toughness and wear resistance. The friction is four times lower than steel on steel making the cap much easier to open and close.

Benefits

- ☑ Consistent open/close force required to operate the fuel cap locking tab.
- ☑ A smooth operation of the fuel cap locking tab.
- ☑ Long wear life.

"They Work! I did not expect a bit of polymer to be worth 90 bucks but I was wrong. It is hard to believe the improvement they bring to the gas cap. They are more than worth the price. You have to turn it to believe it."



Parker Aerospace /
Shaw Aero AeroTough®
Fuel Cap Washers

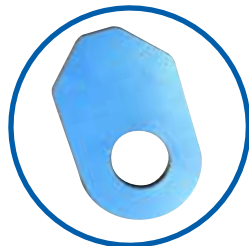

Gabb AeroTough®
Fuel Cap Washers

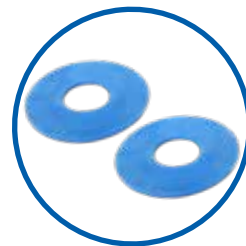

Parker Aerospace /
Shaw Aero AeroTough®
Fuel Cap Washers



Approved Models

Parts Design Approval No. PDA19-19

Fuel Cap			Aircraft Model Applicability	Package Quantity	Product Number	Price
Manufacturer	Model	P/N				
Gabb Special Products	N/A	37810-1	Textron Aviation: Baron Series, Bonanza Series, King Air 90 Series	Single	M-00-1001-1	\$79.00 USD
				Package of 2	M-00-1001-2	\$122.00 USD
				Package of 3	M-00-1001-3	\$162.00 USD
				Package of 4	M-00-1001-4	\$197.00 USD
	N/A	38339	King Air Series, 99 Series	Single	M-00-1002-1	\$79.00 USD
				Package of 2	M-00-1002-2	\$122.00 USD
				Package of 3	M-00-1002-3	\$162.00 USD
				Package of 4	M-00-1002-4	\$197.00 USD
Shaw Aero Device	416 Series	416-50 416-85	Textron Aviation: Baron Series, Bonanza Series	Single	M-00-1000-1	\$79.00 USD
				Package of 2	M-00-1000-2	\$122.00 USD
				Package of 3	M-00-1000-3	\$162.00 USD
				Package of 4	M-00-1000-4	\$197.00 USD
	431 Series	431-9	Textron Aviation: Baron Series, Bonanza Series, King Air 90 Series	Single	M-00-1000-1	\$79.00 USD
				Package of 2	M-00-1000-2	\$122.00 USD
				Package of 3	M-00-1000-3	\$162.00 USD
				Package of 4	M-00-1000-4	\$197.00 USD
	457 Series	457-113 457-115 457-116 457-370	Textron Aviation: Baron Series, Bonanza Series, King Air Series, 1900 Series, 99 Series	Single	M-00-1000-1	\$79.00 USD
				Package of 2	M-00-1000-2	\$122.00 USD
				Package of 3	M-00-1000-3	\$162.00 USD
				Package of 4	M-00-1000-4	\$197.00 USD
531 Series	531-001 531-033 531-046 531-035	Textron Aviation: Baron Series, Bonanza Series, Aerostar Aircraft Corporation: Aerostar Series	Single	M-00-1000-1	\$79.00 USD	
			Package of 2	M-00-1000-2	\$122.00 USD	
			Package of 3	M-00-1000-3	\$162.00 USD	
			Package of 4	M-00-1000-4	\$197.00 USD	
Parker Aerospace	416 Series	416-50	Textron Aviation: Baron Series, Bonanza Series	Single	M-00-1000-1	\$79.00 USD
				Package of 2	M-00-1000-2	\$122.00 USD
				Package of 3	M-00-1000-3	\$162.00 USD
				Package of 4	M-00-1000-4	\$197.00 USD
Parker/Shaw	N/A	39051-3	Textron Aviation: King Air Series	Single	M-04-1001-1	\$103.00 USD
				Package of 2	M-04-1001-2	\$168.00 USD
				Package of 3	M-04-1001-3	\$208.00 USD
				Package of 4	M-04-1001-4	\$243.00 USD

Prices subject to change without notice.

MLG Door Hinge Bushing & Installation Kit

FAA and TCCA Approved

Reduce Maintenance Down Time and Costs by Eliminating the Need to Grease

Overview

An essential part of your aircraft maintenance checklist is the need for periodic lubrication of hard to access door hinge bushings. Achieving proper lubrication is challenging because access is difficult. If these bushings are not lubricated regularly, corrosion will result. This could lead to damage to the aircraft structure.

Marsh Brothers' Grease-Free Non-Metallic AeroTough® bushings will eliminate any chance of corrosion and reduce wear rates, replacing traditional metal bushings. AeroTough® GF is self-lubricating, so they will never require lubrication.

Benefits

- ✓ Self-Lubricating. Never worry about lubricating difficult to access areas again.
- ✓ Reduces maintenance down time.
- ✓ Reduces maintenance costs.
- ✓ Easy to install.

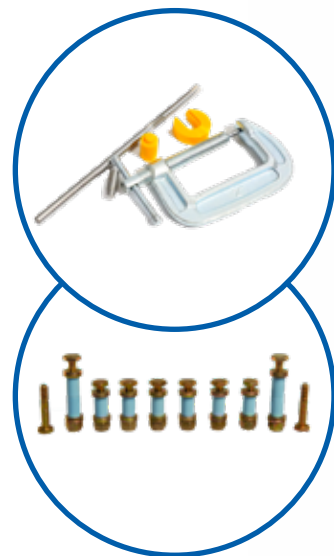

MLG Door Hinge Bushing & Installation Kit

Product Name	Product Number	Price	Approved Models
Baron MLG Door Hinge Kit	M1001	\$496.00 USD	See next page
Baron MLG Door Hinge Installation Kit	M1002	\$120.00 USD	See next page

Prices subject to change without notice.

Approvals

TCCA STC No. SA13-40, FAA STC No. SA03323NY

Approved Models

Baron Models

56TC	58	58A	95	95-55	95-A55	95-B55	95-B55A
95-B55B	95-C55	95-C55A	A56TC	B95	B95A	D55	D55A
D95A	E55	E55A	E95	G58			

Contents

The MLG door hinge bushing kit covers 2 main gear doors and includes:

MBA Part #	Description	Quantity	OEM Cross Reference Part #
AN3-10A	Bolt	8	AN3-10A
MBA10006	AeroTough® GF Bushing	10	LG-BSH001-1 LG-BSH001-3 58-810022-1 58-810022-3 58-810022-3
MBA10058S	Short CRES Sleeve	6	105739-ZM0500 105739-ZP0500 105740-ZR0480
MBA10058L	Long CRES Sleeve	2	
AN960-10	Washer	32	AN960-10
AN365-1032A	Nut	8	AN365-1032A
AN3-15A	Bolt	2	AN3-15A

The Installation kit includes:

Modified C-Clamp	0.251" Straight Flute Reamer	Spacer	Push Pin
------------------	------------------------------	--------	----------

NLG Door Hinge Bushing Kit

FAA and TCCA Approved

Reduce Maintenance Down Time and Costs by Eliminating the Need to Grease

Overview

An essential part of your aircraft maintenance checklist is the need for periodic lubrication of hard to access door hinge bushings. Achieving proper lubrication is challenging because access is difficult. If these bushings are not lubricated regularly, wear will result.

Marsh Brothers' Grease-Free Non-Metallic AeroTough® bushings will eliminate any chance of corrosion and reduce wear rates, replacing traditional metal bushings. AeroTough® GF is a self-lubricating polymer, so they will never require lubrication.

Benefits

- ✓ Self-Lubricating. Never worry about lubricating difficult to access areas again.
- ✓ Reduces maintenance down time.
- ✓ Reduces maintenance costs.
- ✓ Easy to install.



NLG Door Hinge Bushing Kit

Approved Aircraft	Product Number	Price	Approved Models
Baron	M1005	\$355.00 USD	See next page

Prices subject to change without notice.

Approvals

TCCA STC No. SA16-21, FAA STC No. SA03853NY

Approved Models

Baron Models

56TC	58	58A	95	95-55	95-A55	95-B55	95-B55A
95-B55B	95-C55	95-C55A	A56TC	B95	B95A	D55	D55A
D95A	E55	E55A	E95	G58	A23CE	58P	58PA
58TC	58TCA						

Contents

MBA Part #	Description	Quantity	OEM Cross Reference Part #
AN3-7A	Bolt	4	AN3-7A
MBA10099	SS Sleeve	4	N/A
MBA10098	ATGF Bushing	4	105739S-ZG0250
AN960-10A	Washer	8	AN960-10A
AN365-1032A	Nut	4	AN365-1032A
19/64" Drill Bit	Drill Bit	1	N/A
5/16" Drill Bit	Drill Bit	1	N/A

Polymer Spinner Washers

MBA spinner washers are designed to last for the life of the airplane

Overview

MBA spinner washers are CNC machined from a flexible polymer, not stamped from a sheet of Nylon.

The screw hole is sized so they need to be twisted on to the 10/32 screw. You'll find they'll outlast the screw. And, your mechanics won't lose them when they remove the screws during your annual inspection.

These washers are designed to assume the flat shape of the screw head on the outer surface and match the curvature of the spinner on the inside. They won't put any stress on the aluminum spinner trying to flatten it where it's supposed to be round.

Benefits

- ☑ We believe these washers will reduce or eliminate the tendency for spinners to crack.
- ☑ These washers can express your personality; like the red brake calipers on your car. If you're one who likes to show you value quality, pick yellow. If you prefer not to stand out in a crowd, pick clear. Grey is for conservatives who want to be sure they're still in place.

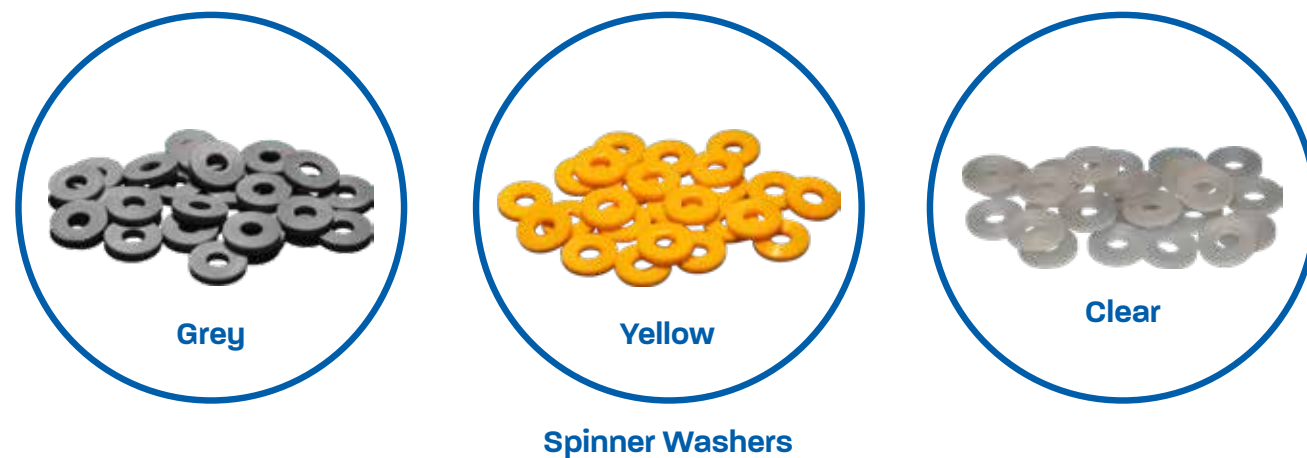

Contents

MBA Part #	Description	Quantity	Price
M1020-5	Polymer Spinner Washers (Yellow)	5	\$19. ⁰⁰ USD
M1020-10	Polymer Spinner Washers (Yellow)	10	\$40. ⁰⁰ USD
M1020-25	Polymer Spinner Washers (Yellow)	25	\$108. ⁰⁰ USD
M1026-5	Polymer Spinner Washers (Grey)	5	\$19. ⁰⁰ USD
M1026-10	Polymer Spinner Washers (Grey)	10	\$40. ⁰⁰ USD
M1026-25	Polymer Spinner Washers (Grey)	25	\$108. ⁰⁰ USD
M1027-5	Polymer Spinner Washers (Clear)	5	\$19. ⁰⁰ USD
M1027-10	Polymer Spinner Washers (Clear)	10	\$40. ⁰⁰ USD
M1027-25	Polymer Spinner Washers (Clear)	25	\$108. ⁰⁰ USD

Prices subject to change without notice.



Bonanza Products Overview

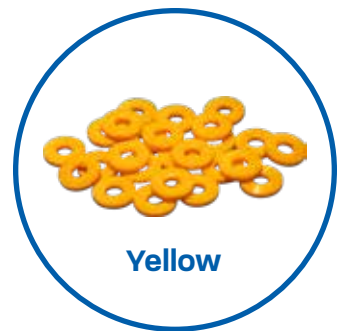

Spinner Washers

Yellow



Grey



Clear



Parker Aerospace /
Shaw Aero AeroTough®
Fuel Cap Washers

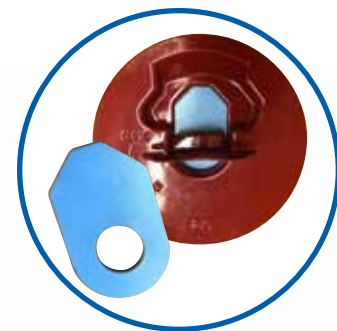

Parker Aerospace /
Shaw Aero AeroTough®
Fuel Cap Washers

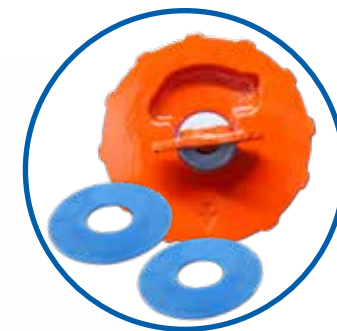

Gabb AeroTough®
Fuel Cap Washers



NLG Door Hinge
Busing Kit

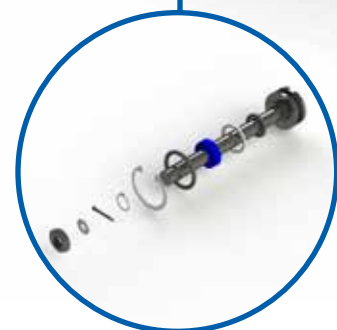

Brake Master Cylinder
Upgrade/Repair Kit



MLG Door Hinge
Installation Kit

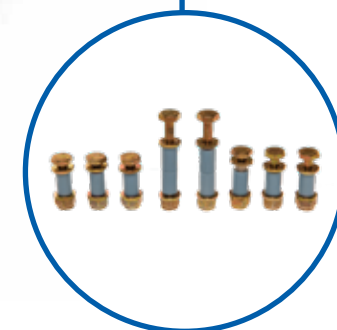

MLG Door
Hinge Kit

Brake Master Cylinder Upgrade/Repair Kit

FAA and TCCA Approved

Improve Your Aircraft While Reducing Your Maintenance Costs

Overview

The OEM brake master cylinders use a rubber lip seal as the piston rod seal and the rod runs in a bronze/aluminum gland. The Marsh Brothers Aviation Brake Master Cylinder Upgrade/Repair Kit includes all the internal hardware to upgrade the cylinder and replace all elements that could leak or deteriorate. The most important element is the V-ring seal made from MBA's seal polymer which replaces the stock seal made from molded rubber.

Instead of buying a brand new master cylinder assembly, rebuild the one you have to better-than-new condition.

Benefits

- ✓ The MBA dynamic rod seal is more flexible than rubber under cold conditions and less prone to leak when the aircraft is not in a heated hangar in winter.
- ✓ There's nothing else to buy; everything you need to rebuild the cylinder is contained in the kit.
- ✓ Rebuild your existing cylinder and save money in the process.
- ✓ The MBA dynamic seal is more wear-resistant than rubber.



Note: The Piston is not included in this kit. Refer to the Contents section on next page.

Approved Aircraft	Product Number	Price	Approved Models
Beechcraft® Bonanza	M-03-1001-1	\$126.00 USD	See next page
Beechcraft® Bonanza	M-03-1001-3	\$126.00 USD	See next page

Prices subject to change without notice.

Approvals

TCCA STC No. SA21-5, FAA STC No. SA04634NY

Approved Models

Bonanza Models

35	A35	B35	C35	D35	E35	F35	G35	35R
35-33	35-A33	35-B33	35-C33	35-C33A	36	A36	A36TC	B36TC
E33	E33A	E33C	F33	F33A	F33C	G33	G36	H35
J35	K35	M35	N35	P35	S35	V35	V35A	V35B

Applicability

Product Number	OEM P/N 96-380034-()			
	-25	-23		
M-03-1001-1	X			
M-03-1000-3		X		

Contents

Item#	MBA Part #	Description	QTY	OEM Cross Reference Part #
1	AN316-5R	Nut Rod End Jam	1	AN316-5R
2	MS16625-1100	Internal Retaining Ring	1	MS16625-1100
3	MBA-03-10000-1	Piston Rod Gland Seal	1	A57G401 / AN6227B6
4	MS28775-117	O-Ring (Static Gland)	1	AN6227B11
5	MS28775-111	O-Ring (Piston Head)	1	AN6227B9
6	MS28774-013	Back-Up Ring (Piston Head)	1	N/A
7	MS24665-132	Cotter Pin	1	AN380C2-2
8	MS16624-1037	External Retaining Ring	1	N/A

Note: This kit does not fit brake master cylinders manufactured by Gerdes or Paramount.

Caution: Thorseal® is made from Marsh Brothers proprietary material known as AeroLas™-Flex which is not compatible with phosphate ester hydraulic fluid, commercially known as Skydrol. Exposure to this fluid contamination will damage the seals.

AeroTough® GF Fuel Cap Washers

FAA, TCCA and EASA Approved

Avoid the hassle of difficult to open and close fuel caps.
An easier way.

Overview

Installing Marsh Brothers' Non-Metallic AeroTough® GF (Grease-Free) Fuel Cap Washers will ensure your fuel cap remains safe and functional, making opening and closing much easier. The washer which is CNC machined to exact shape is made from a polymer produced by Marsh Brothers' parent company and is not available commercially from any other source. It has extraordinary toughness and wear resistance. The friction is four times lower than steel on steel making the cap much easier to open and close.

Benefits

- ✓ Consistent open/close force required to operate the fuel cap locking tab.
- ✓ A smooth operation of the fuel cap locking tab.
- ✓ Long wear life.

"They Work! I did not expect a bit of polymer to be worth 90 bucks but I was wrong. It is hard to believe the improvement they bring to the gas cap. They are more than worth the price. You have to turn it to believe it."



Parker Aerospace /
Shaw Aero AeroTough®
Fuel Cap Washers

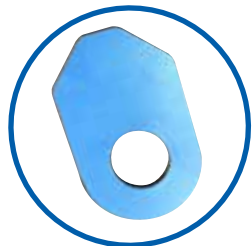

Gabb AeroTough®
Fuel Cap Washers

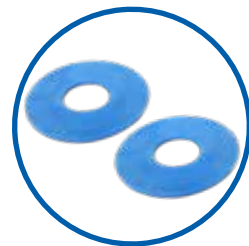

Parker Aerospace /
Shaw Aero AeroTough®
Fuel Cap Washers



Approved Models

Parts Design Approval No. PDA19-19

Fuel Cap			Aircraft Model Applicability	Package Quantity	Product Number	Price
Manufacturer	Model	P/N				
Gabb Special Products	N/A	37810-1	Textron Aviation: Baron Series, Bonanza Series, King Air 90 Series	Single	M-00-1001-1	\$79.00 USD
				Package of 2	M-00-1001-2	\$122.00 USD
				Package of 3	M-00-1001-3	\$162.00 USD
				Package of 4	M-00-1001-4	\$197.00 USD
	38339	King Air Series, 99 Series	Single	M-00-1002-1	\$79.00 USD	
			Package of 2	M-00-1002-2	\$122.00 USD	
			Package of 3	M-00-1002-3	\$162.00 USD	
			Package of 4	M-00-1002-4	\$197.00 USD	
Shaw Aero Device	416 Series	416-50 416-85	Textron Aviation: Baron Series, Bonanza Series	Single	M-00-1000-1	\$79.00 USD
				Package of 2	M-00-1000-2	\$122.00 USD
				Package of 3	M-00-1000-3	\$162.00 USD
				Package of 4	M-00-1000-4	\$197.00 USD
	431 Series	431-9	Textron Aviation: Baron Series, Bonanza Series, King Air 90 Series	Single	M-00-1000-1	\$79.00 USD
				Package of 2	M-00-1000-2	\$122.00 USD
				Package of 3	M-00-1000-3	\$162.00 USD
				Package of 4	M-00-1000-4	\$197.00 USD
	457 Series	457-113 457-115 457-116 457-370	Textron Aviation: Baron Series, Bonanza Series, King Air Series, 1900 Series, 99 Series	Single	M-00-1000-1	\$79.00 USD
				Package of 2	M-00-1000-2	\$122.00 USD
				Package of 3	M-00-1000-3	\$162.00 USD
				Package of 4	M-00-1000-4	\$197.00 USD
531 Series	531-001 531-033 531-046 531-035	Textron Aviation: Baron Series, Bonanza Series, Aerostar Aircraft Corporation: Aerostar Series	Single	M-00-1000-1	\$79.00 USD	
			Package of 2	M-00-1000-2	\$122.00 USD	
			Package of 3	M-00-1000-3	\$162.00 USD	
			Package of 4	M-00-1000-4	\$197.00 USD	
Parker Aerospace	416 Series	416-50	Textron Aviation: Baron Series, Bonanza Series	Single	M-00-1000-1	\$79.00 USD
				Package of 2	M-00-1000-2	\$122.00 USD
				Package of 3	M-00-1000-3	\$162.00 USD
				Package of 4	M-00-1000-4	\$197.00 USD
Parker/Shaw	N/A	39051-3	Textron Aviation: King Air Series	Single	M-04-1001-1	\$103.00 USD
				Package of 2	M-04-1001-2	\$168.00 USD
				Package of 3	M-04-1001-3	\$208.00 USD
				Package of 4	M-04-1001-4	\$243.00 USD

Prices subject to change without notice.

MLG Door Hinge Bushing & Installation Kit

FAA and TCCA Approved

Reduce Maintenance Down Time and Costs by Eliminating the Need to Grease

Overview

An essential part of your aircraft maintenance checklist is the need for periodic lubrication of hard to access door hinge bushings. Achieving proper lubrication is challenging because access is difficult. If these bushings are not lubricated regularly, corrosion will result. This could lead to damage to the aircraft structure.

Marsh Brothers' Grease-Free Non-Metallic AeroTough® bushings will eliminate any chance of corrosion and reduce wear rates, replacing traditional metal bushings. AeroTough® GF is self-lubricating, so they will never require lubrication.

Benefits

- ✓ Self-Lubricating. Never worry about lubricating difficult to access areas again.
- ✓ Reduces maintenance down time.
- ✓ Reduces maintenance costs.
- ✓ Easy to install.



MLG Door Hinge Bushing & Installation Kit

Product Name	Product Number	Price	Approved Models
Bonanza MLG Door Hinge Kit	M1000	\$496. ⁰⁰ USD	See next page
Bonanza MLG Door Hinge Installation Kit	M1002	\$120. ⁰⁰ USD	See next page

Prices subject to change without notice.

Approvals

TCCA STC No. SA13-40, FAA STC No. SA03323NY

Approved Models

Bonanza Models

56TC	58	58A	95	95-55	95-A55	95-B55	95-B55A
95-B55B	95-C55	95-C55A	A56TC	B95	B95A	D55	D55A
D95A	E55	E55A	E95	G58			

Contents

The MLG door hinge bushing kit covers 2 main gear doors and includes:

MBA Part #	Description	Quantity	OEM Cross Reference Part #
AN3-10A	Bolt	8	AN3-10A
MBA10006	AeroTough® GF Bushing	10	LG-BSH001-1 LG-BSH001-3 58-810022-1 58-810022-3 58-810022-3
MBA10058S	Short CRES Sleeve	6	105739-ZM0500 105739-ZP0500 105740-ZR0480
MBA10058L	Long CRES Sleeve	2	
AN960-10	Washer	32	AN960-10
AN365-1032A	Nut	8	AN365-1032A
AN3-15A	Bolt	2	AN3-15A

The Installation kit includes:

Modified C-Clamp	0.251" Straight Flute Reamer	Spacer	Push Pin
------------------	------------------------------	--------	----------

NLG Door Hinge Bushing Kit

FAA and TCCA Approved

Reduce Maintenance Down Time and Costs by Eliminating the Need to Grease

Overview

Propeller slipstream impacts Bonanza NLG door hinges, causing vibration that leads to the door hinge bearing bores being beaten up. The Marsh Brothers' NLG door hinge replacement kit solves the problem by transferring the wearing surface from the aluminum arms to AeroTough® GF (Grease-Free) bushings pressed into the arms. The Marsh Brothers kit includes stainless steel sleeves that can't corrode or wear. You get the drills needed to repair the arms and provide a perfect fit for the bushings.

The tough nature of Marsh Brothers bushings eliminates damage caused to the softer aluminum and results in a joint that should last without play for years.

Benefits

- Self-Lubricating. Never worry about lubricating difficult to access areas again.
- Reduces maintenance down time.
- Reduces maintenance costs.
- Easy to install.



NLG Door Hinge Bushing Kit

Approved Aircraft	Product Number	Price	Approved Models
Bonanza	M1005	\$355.00 USD	See next page

Prices subject to change without notice.

Approvals

TCCA STC No. SA16-21, FAA STC No. SA03853NY

Approved Models

Bonanza Models

35	A35	B35	C35	D35	E35	F35	G35
35R	35-33	35-A33	35-B33	35-C33	35-C33A	36	A36
A36TC	B36TC	E33	E33A	E33C	F33	F33A	F33C
G33	G36	H35	J35	K35	M35	N35	P35
S35	V35	V35A	V35B				

Contents

MBA Part #	Description	Quantity	OEM Cross Reference Part #
AN3-7A	Bolt	4	AN3-7A
MBA10099	SS Sleeve	4	N/A
MBA10098	ATGF Bushing	4	105739S-ZG0250
AN960-10A	Washer	8	AN960-10A
AN365-1032A	Nut	4	AN365-1032A
19/64" Drill Bit	Drill Bit	1	N/A
5/16" Drill Bit	Drill Bit	1	N/A

Polymer Spinner Washers

MBA spinner washers are designed to last for the life of the airplane

Overview

MBA spinner washers are CNC machined from a flexible polymer, not stamped from a sheet of Nylon.

The screw hole is sized so they need to be twisted on to the 10/32 screw. You'll find they'll outlast the screw. And, your mechanics won't lose them when they remove the screws during your annual inspection.

These washers are designed to assume the flat shape of the screw head on the outer surface and match the curvature of the spinner on the inside. They won't put any stress on the aluminum spinner trying to flatten it where it's supposed to be round.

Benefits

- ☑ We believe these washers will reduce or eliminate the tendency for spinners to crack.
- ☑ These washers can express your personality; like the red brake calipers on your car. If you're one who likes to show you value quality, pick yellow. If you prefer not to stand out in a crowd, pick clear. Grey is for conservatives who want to be sure they're still in place.



Grey

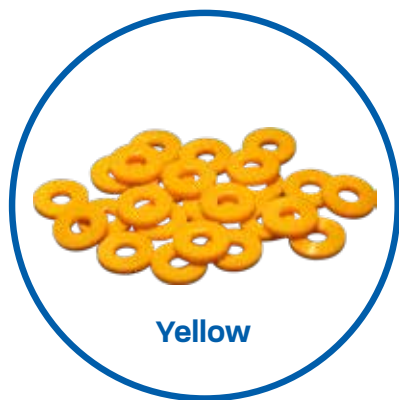

Yellow



Clear

Spinner Washers

Contents

MBA Part #	Description	Quantity	Price
M1020-5	Polymer Spinner Washers (Yellow)	5	\$19. ⁰⁰ USD
M1020-10	Polymer Spinner Washers (Yellow)	10	\$40. ⁰⁰ USD
M1020-25	Polymer Spinner Washers (Yellow)	25	\$108. ⁰⁰ USD
M1026-5	Polymer Spinner Washers (Grey)	5	\$19. ⁰⁰ USD
M1026-10	Polymer Spinner Washers (Grey)	10	\$40. ⁰⁰ USD
M1026-25	Polymer Spinner Washers (Grey)	25	\$108. ⁰⁰ USD
M1027-5	Polymer Spinner Washers (Clear)	5	\$19. ⁰⁰ USD
M1027-10	Polymer Spinner Washers (Clear)	10	\$40. ⁰⁰ USD
M1027-25	Polymer Spinner Washers (Clear)	25	\$108. ⁰⁰ USD

Prices subject to change without notice.



King Air Products Overview

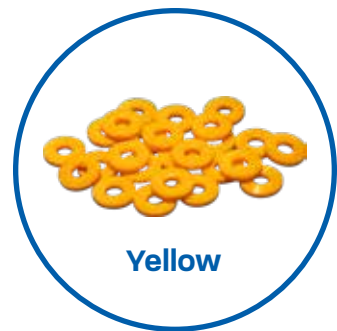

Spinner Washers

Yellow



Parker Aerospace /
Shaw Aero AeroTough®
Fuel Cap Washers

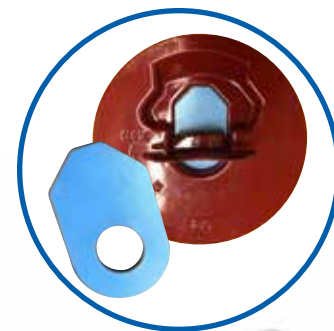

Parker Aerospace /
Shaw Aero AeroTough®
Fuel Cap Washers



Gabb AeroTough®
Fuel Cap Washers



Grey



Clear



Brake Master Cylinder
Upgrade/Repair Kit



NLG Door Hinge
Bushing Kit

King Air/Beech 1900/Model 99 Brake Master Cylinder Upgrade/Repair Kit

FAA and TCCA Approved

Improve the Operational Reliability of your Aircraft

Overview

Marsh Brothers' Brake Master Cylinder Upgrade & Repair Kit gives your leaking cylinder a new lease on life that's actually better than the OEM product, and here's why. O-rings typically don't make good dynamic piston rod seals. They're fine for static seals but where movement and wear is involved, there are better options. This upgrade kit replaces the piston rod seal with a specially designed lip seal made of a much more wear-resistant polymer than the OEM O-ring. The MBA gland seal is a lip seal and it offers much more flexibility than an O-ring. If your aircraft is parked on a cold ramp, the rubber seals can harden and shrink. Until the cabin warms up, they can leak. Maybe not much, but a leak is a leak. The MBA rebuild kit gives you everything you need to totally rebuild your master cylinder, and it's an easy job.

Benefits

- Everything needed to rebuild your cylinder is included in the MBA kit including tooling, seal compression ring, thread sleeve (to protect the inner lip) and push tube (tool), cotter pin, washers static O-rings and circlip.
- Reduces unscheduled maintenance downtime.

Brake Master Cylinder Upgrade/Repair Kit



Note: The Piston is not included in this kit. Refer to the Contents section on next page.

Approved Aircraft	Product Number	Price	Approved Models
Beechcraft® King Air®	M-03-1000-()	\$186.00 USD	See next page
Beechcraft® 1900® Aircraft	M-03-1000-()	\$186.00 USD	See next page
Model 99	M-03-1000-()	\$186.00 USD	See next page

Prices subject to change without notice.

Approvals

TCCA STC No. SA21-5, FAA STC No. SA04634NY

Approved Models

King Air

65-90	65-A90	C90	C90A	E90	F90	C90GT	H90	100
A100	B100	200	200C	200CT	200T	B200	B200C	B200CT
B200T	B200CGT	B200GT	300	300LW	B300	B300C		

Beech 1900

1900	1900C	1900D						
------	-------	-------	--	--	--	--	--	--

Model 99

99	99A	A99	A99A	B99	C99			
----	-----	-----	------	-----	-----	--	--	--

Applicability

Product Number	OEM P/N 90-380001-()		
	-23	-29	-33
M-03-1000-1	X		
M-03-1000-3		X	X

Contents

Item#	MBA Part #	Description	QTY	OEM Cross Reference Part #
1	AN316-5R	Nut Rod End Jam	1	AN316-5R
2	MS16625-1100	Internal Retaining Ring	1	MS16625-1100
3	MBA-03-10000-1	Piston Rod Gland Seal	1	A57G401 / AN6227B6
4	MS28775-117	O-Ring (Static Gland)	1	01-117
5	MS28775-210	O-Ring (Piston Head)	1	01-117
6	MS28774-019	Back-Up Ring (Piston Head)	1	N/A
7	MS24665-132	Cotter Pin	1	AN380C2-2
8	MS16624-1037	External Retaining Ring	1	N/A

Note: This kit does not fit brake master cylinders manufactured by Gerdes or Paramount.

Caution: Thorseal® is made from Marsh Brothers proprietary material known as AeroLas™-Flex which is not compatible with phosphate ester hydraulic fluid, commercially known as Skydrol. Exposure to this fluid contamination will damage the seals.

NLG Door Hinge Kit

FAA, TCCA and EASA Approved

Reduce Downtime with Grease-Free AeroTough® Bushings

Overview

An essential part of your aircraft maintenance checklist is the need for periodic lubrication of hard-to-get-at door hinge bushings. Achieving proper lubrication is challenging because access is difficult. If these bushings are not lubricated regularly, corrosion will result. This can cause the bushing and sleeve to fuse together over time, resulting in problems with the door rigging. If not corrected, this could lead to a progressive stiffening of the door hinge arm joint and in a worst-case scenario damage to the airframe door hinge bracket – a safety issue and at best, an expensive repair. The Marsh Brothers kit is insurance against the possibility of future problems.

Benefits

- Reduced Wear.
- Improved Reliability.
- Reduced Maintenance Costs.
- Reduced Maintenance Downtime.



Approved Aircraft	Product Number	Price	Approved Models
Textron Aviation Models	M-04-1000-1	\$640.00 USD	See next page

Prices subject to change without notice.

Approvals

TCCA STC No. PDA20-1

Approved Models

65-90	65-A90	C90	E90	H90	C90A	C90GT	F90
200	200C	200CT	200T	B200	B200C	B200CT	B200T
B200GT	B200CGT	300	300LW	B300	B300C		

Contents

MBA Part #	Description	Quantity	OEM Cross Reference Part #
MBA-04-10006	SS Sleeve	4 per kit	105740-ZP0385
MBA-04-10005	ATGF Bushing	4 per kit	A638-1

AeroTough® GF Fuel Cap Washers

FAA, TCCA and EASA Approved

Avoid the hassle of difficult to open and close fuel caps.
An easier way.

Overview

Installing Marsh Brothers' Non-Metallic AeroTough® GF (Grease-Free) Fuel Cap Washers will ensure your fuel cap remains safe and functional, making opening and closing much easier. The washer which is CNC machined to exact shape is made from a polymer produced by Marsh Brothers' parent company and is not available commercially from any other source. It has extraordinary toughness and wear resistance. The friction is four times lower than steel on steel making the cap much easier to open and close.

Benefits

- ☑ Consistent open/close force required to operate the fuel cap locking tab.
- ☑ A smooth operation of the fuel cap locking tab.
- ☑ Long wear life.

"They Work! I did not expect a bit of polymer to be worth 90 bucks but I was wrong. It is hard to believe the improvement they bring to the gas cap. They are more than worth the price. You have to turn it to believe it."



Parker Aerospace / Shaw Aero AeroTough® Fuel Cap Washers

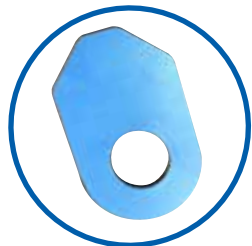

Gabb AeroTough® Fuel Cap Washers



Parker Aerospace / Shaw Aero AeroTough® Fuel Cap Washers



Approved Models

Parts Design Approval No. PDA19-19

Fuel Cap			Aircraft Model Applicability	Package Quantity	Product Number	Price
Manufacturer	Model	P/N				
Gabb Special Products	N/A	37810-1	Textron Aviation: Baron Series, Bonanza Series, King Air 90 Series	Single	M-00-1001-1	\$79.00 USD
				Package of 2	M-00-1001-2	\$122.00 USD
				Package of 3	M-00-1001-3	\$162.00 USD
				Package of 4	M-00-1001-4	\$197.00 USD
	N/A	38339	King Air Series, 99 Series	Single	M-00-1002-1	\$79.00 USD
				Package of 2	M-00-1002-2	\$122.00 USD
				Package of 3	M-00-1002-3	\$162.00 USD
				Package of 4	M-00-1002-4	\$197.00 USD
Shaw Aero Device	416 Series	416-50 416-85	Textron Aviation: Baron Series, Bonanza Series	Single	M-00-1000-1	\$79.00 USD
				Package of 2	M-00-1000-2	\$122.00 USD
				Package of 3	M-00-1000-3	\$162.00 USD
				Package of 4	M-00-1000-4	\$197.00 USD
	431 Series	431-9	Textron Aviation: Baron Series, Bonanza Series, King Air 90 Series	Single	M-00-1000-1	\$79.00 USD
				Package of 2	M-00-1000-2	\$122.00 USD
				Package of 3	M-00-1000-3	\$162.00 USD
				Package of 4	M-00-1000-4	\$197.00 USD
	457 Series	457-113 457-115 457-116 457-370	Textron Aviation: Baron Series, Bonanza Series, King Air Series, 1900 Series, 99 Series	Single	M-00-1000-1	\$79.00 USD
				Package of 2	M-00-1000-2	\$122.00 USD
				Package of 3	M-00-1000-3	\$162.00 USD
				Package of 4	M-00-1000-4	\$197.00 USD
531 Series	531-001 531-033 531-046 531-035	Textron Aviation: Baron Series, Bonanza Series, Aerostar Aircraft Corporation: Aerostar Series	Single	M-00-1000-1	\$79.00 USD	
			Package of 2	M-00-1000-2	\$122.00 USD	
			Package of 3	M-00-1000-3	\$162.00 USD	
			Package of 4	M-00-1000-4	\$197.00 USD	
Parker Aerospace	416 Series	416-50	Textron Aviation: Baron Series, Bonanza Series	Single	M-00-1000-1	\$79.00 USD
				Package of 2	M-00-1000-2	\$122.00 USD
				Package of 3	M-00-1000-3	\$162.00 USD
				Package of 4	M-00-1000-4	\$197.00 USD
Parker/Shaw	N/A	39051-3	Textron Aviation: King Air Series	Single	M-04-1001-1	\$103.00 USD
				Package of 2	M-04-1001-2	\$168.00 USD
				Package of 3	M-04-1001-3	\$208.00 USD
				Package of 4	M-04-1001-4	\$243.00 USD

Prices subject to change without notice.

Polymer Spinner Washers

MBA spinner washers are designed to last for the life of the airplane

Overview

MBA spinner washers are CNC machined from a flexible polymer, not stamped from a sheet of Nylon.

The screw hole is sized so they need to be twisted on to the 10/32 screw. You'll find they'll outlast the screw. And, your mechanics won't lose them when they remove the screws during your annual inspection.

These washers are designed to assume the flat shape of the screw head on the outer surface and match the curvature of the spinner on the inside. They won't put any stress on the aluminum spinner trying to flatten it where it's supposed to be round.

Benefits

- ☑ We believe these washers will reduce or eliminate the tendency for spinners to crack.
- ☑ These washers can express your personality; like the red brake calipers on your car. If you're one who likes to show you value quality, pick yellow. If you prefer not to stand out in a crowd, pick clear. Grey is for conservatives who want to be sure they're still in place.



Grey

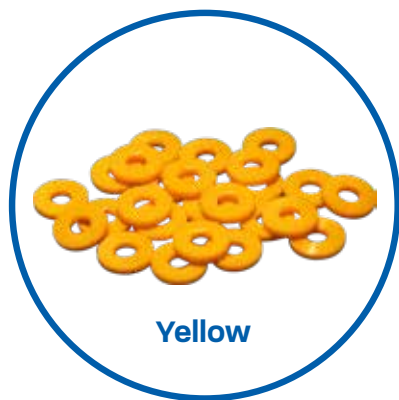

Yellow



Clear

Spinner Washers

Contents

MBA Part #	Description	Quantity	Price
M1020-5	Polymer Spinner Washers (Yellow)	5	\$19.00 USD
M1020-10	Polymer Spinner Washers (Yellow)	10	\$40.00 USD
M1020-25	Polymer Spinner Washers (Yellow)	25	\$108.00 USD
M1026-5	Polymer Spinner Washers (Grey)	5	\$19.00 USD
M1026-10	Polymer Spinner Washers (Grey)	10	\$40.00 USD
M1026-25	Polymer Spinner Washers (Grey)	25	\$108.00 USD
M1027-5	Polymer Spinner Washers (Clear)	5	\$19.00 USD
M1027-10	Polymer Spinner Washers (Clear)	10	\$40.00 USD
M1027-25	Polymer Spinner Washers (Clear)	25	\$108.00 USD

Prices subject to change without notice.



Aerostar Products Overview

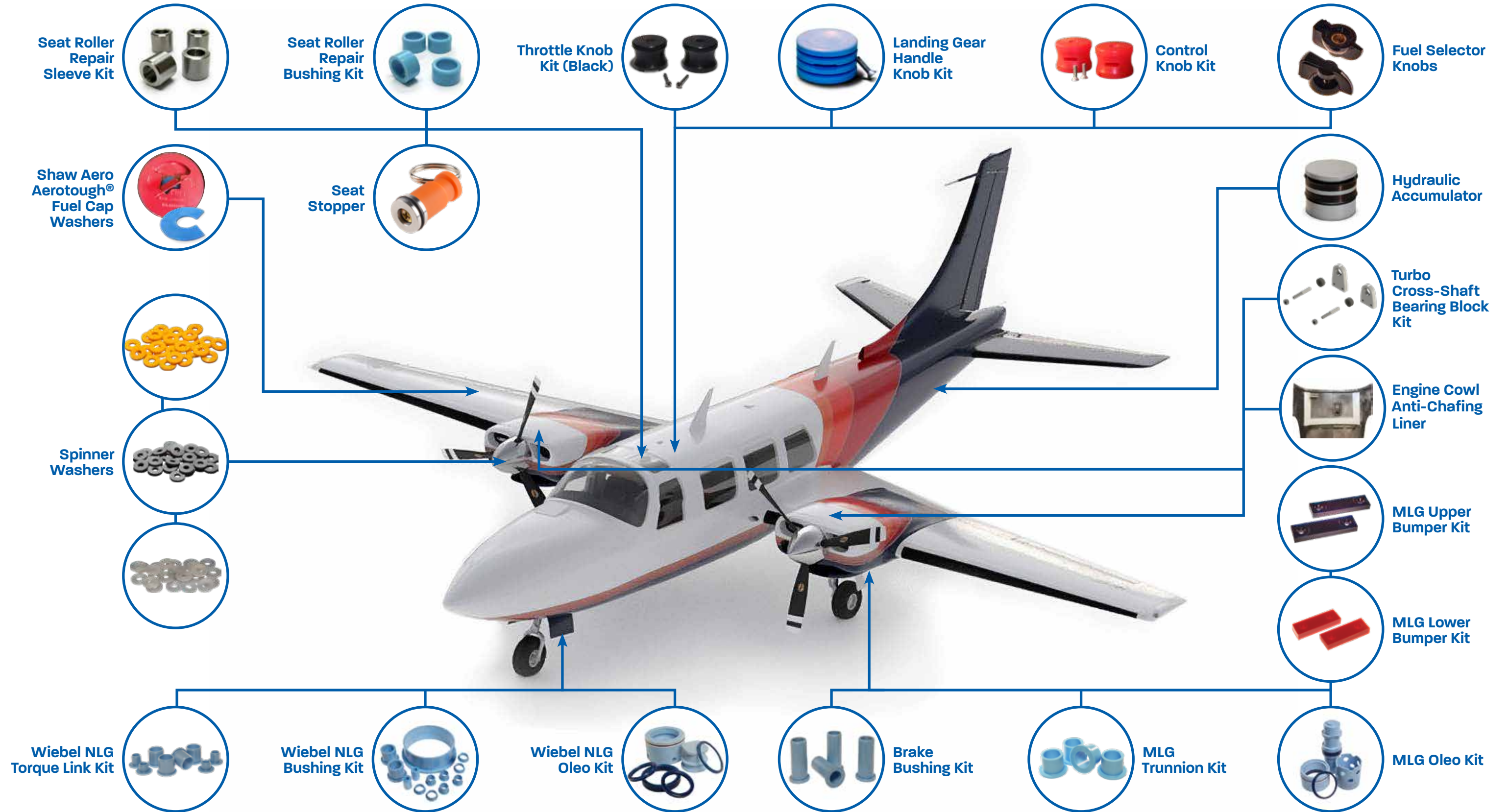

Brake Bushing Kit

FAA and TCCA Approved

Reduce Maintenance by Eliminating the Need for Periodic Greasing

Overview

Marsh Brothers' AeroTough® polymer bushes are able to replace the steel bushings in the brake anchor block and because the effective length is greater, pin support is increased. If the slave cylinder assemblies are blocked from sliding in the anchor block there is increased risk of wear of the outboard brake pads after release of the pedal. The brake assembly needs to move slightly away from the disc in the outboard direction after brake release.

Initially, the MBA bushings had the flange on the inside face but a subsequent version reversed to flange outboard design so there can be no migration of the bushing inboard towards the hot pad carrier.

While some mechanics lubricate the pins, the best solution is no lubrication beyond what is contained within the AeroTough® polymer.

Benefits

- ✓ No metal-to-metal contact.
- ✓ Full support of the pin with 50% more contact area.
- ✓ No need to lubricate.
- ✓ Reduced pad/disc wear.



Brake Bushing Kit

Product Name	Product Number	Price	Approved Models
Aerostar Brake Bushing Kit	M1006	\$769.00 USD	600, 601, 601P, 602P, 700P

Prices subject to change without notice.

Approvals

TCCA STC No. SA14-43, FAA STC No. SA03484NY

Contents

MBA Part #	Description	Quantity	Cleveland Brake Assemblies
MBA10019	Aerostar Brake Bushing Kit	4	30-93, 30-93A, 30-93B, 30-93C, 30-93D, 30-93E, 30-145

Aerostar MLG Upper & Lower Bumper Kits

FAA and TCCA Approved

Durable & Long Lasting. Reducing the Risk of Damage to the Airframe

Overview

The MLG Upper (Blue) bumpers for the landing gear protect the wing structure during gear retraction and the MLG Lower (Red) bumpers cushion the fuselage structure from damage from the bellcrank as the clamshell doors open fully. The OEM rubber bumpers suffer from deformation and are often beaten out of shape.

Marsh Brothers' bumpers are made from a tougher and more durable, engineered polymer that should last as long as the airframe. They will never crack or bulge and are easy to install!

Benefits

- ✓ Easy to install: Direct replacement for OEM rubber bumpers, using original hardware.
- ✓ Increased abrasion resistance.
- ✓ Durable and long lasting.
- ✓ Superior strength.



Note: The Upper and Lower Bumper kits are sold separately.

MLG Upper Bumper Kit

MLG Lower Bumper Kit

Product Name	Product Number	Price	Approved Models
Aerostar MLG Upper Bumper Kit (Blue)	M1018	\$263.00 USD	600, 601, 601P, 602P, 700P
Aerostar MLG Lower Bumper Kit (Red)	M1019	\$263.00 USD	

Prices subject to change without notice.

Approvals

TCCA STC No. SA14-43, FAA STC No. SA03484NY

Contents

Product Number: M1018

MBA Part #	Description	Quantity
MBA10002	Aerostar MLG Upper Bumper Kit (Blue)	2

Product Number: M1019

MBA Part #	Description	Quantity
MBA10064	Aerostar MLG Lower Bumper Kit (Red)	2

MLG Oleo Kit

FAA and TCCA Approved

Reduce Maintenance Downtime and Costs

Overview

Marsh Brothers' Non-Metallic AeroTough® GF floating piston, upper bearing (cap) and lower bearing/gland not only reduce the aircraft's empty weight but bring sealing integrity benefits.

The lower gland made from AeroTough® carries the same OEM outer static seal and back-up rings but the steel wiper is replaced by a polymer lip which is softer and less prone to scratch the steel piston. The seal is a V-ring polymer seal with upward-facing lips giving a more resilient seal than the stock O-ring. In cold weather conditions, the O-ring seal can leak fluid, requiring re-servicing of the gear.

The floating piston was not originally included in the MBA kit but was added after reports of the OEM piston sticking in the steel piston bore. The floating piston is fit with two opposing lip seals; one seals against Nitrogen and the other against hydraulic fluid.

Note: There has been a few cases of the lower floating piston seal being damaged on installation due to inadequate de-burring of the fluid transfer holes in the top of the steel piston. These holes must have the inner edges smoothed (a Dremel tool with a small sanding drum works best) if there is any indication that the edges are sharp.

Benefits

- ✓ Better sealing characteristics than is possible with O-rings.
- ✓ Avoids frequent gear re-servicing due to leaks.
- ✓ Reduced empty weight.
- ✓ No more "flat struts".



MLG Oleo Kit

Product Name	Product Number	Price	Approved Models
Aerostar MLG Oleo Kit	M1004	\$4,015. ⁰⁰ USD	600, 601, 601P, 602P, 700P

Prices subject to change without notice.

Approvals

TCCA STC No. SA14-43, FAA STC No. SA03484NY

Contents

MBA Part #	Description	Quantity	Reference OEM Part #
MBA10016	Gland	1	400071-501
MBA10020	Floating Piston	1	400069-501
MBA10071	Floating Piston Seal	2	MS28774-326 (qty.2), MS28775-326 (qty.1)
MBA10017	Oleo Cap	1	400066-501
MBA10024	Oleo Wiper Seal	1	AN6231-23
MBA10025	Gland Seal	1	MS28775-331(qty.1), MS28774-331(qty.2)
MS28774-148	Back-up Ring	2	MS28774-148
MS28775-148	O-Ring	1	MS28775-148

MLG Trunnion Kit

FAA and TCCA Approved

Reduce Maintenance Costs by Eliminating the Need to Grease with AeroTough® GF (Grease-Free) Bushings

Overview

Traditional landing gear design incorporates the use of metal bushings at dynamic joints. An essential part of your landing gear performing optimally is periodic lubrication at dynamic joints. Achieving proper lubrication is challenging in tough-to-access places. Improper lubrication means the joint runs with metal on metal. If you don't determine why grease didn't enter the joint, you are risking bushing and pin wear or worse; a seized joint. If grease doesn't emerge at the edges of the joint, it indicates inadequate greasing. You must disassemble the joint and find out why the grease is not entering the joint.

With the Marsh Brothers MLG Trunnion kit installed; you can forget about greasing. The risk of a seized joint drops to zero. Main landing gear airframe trunnion bushing kits from Marsh Brothers Aviation are for all models of Aerostar aircraft. One kit will cover one main landing gear (both sides).

Benefits

- ✓ Eliminates the need to grease with AeroTough® GF (Grease-Free) bushings.
- ✓ Never worry about lubricating tough-to-access places.
- ✓ Eliminates the possibility of metal-to-metal contact.
- ✓ Durable and long lasting.

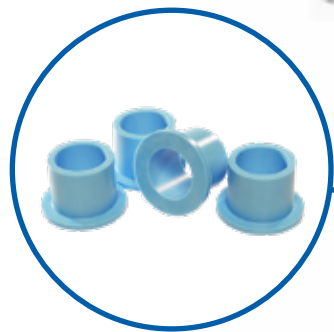

MLG Trunnion Kit



Product Name	Product Number	Price	Approved Models
Aerostar MLG Trunnion Kit	M1007	\$774.00 USD	600, 601, 601P, 602P, 700P

Prices subject to change without notice.

Approvals

TCCA STC No. SA14-43, FAA STC No. SA03484NY

Contents

MBA Part #	Description	Quantity	OEM Cross Reference Part #
MBA10029	ATGF Trunnion Bushing	4	920002-001

Wiebel NLG Bushing Kit

FAA and TCCA Approved

Reduces Maintenance Costs and Downtime

Overview

The Marsh Brothers Wiebel NLG upgrade bushing kit replaces the two bronze upper trunnion bushings, the 4 jury brace bronze bushings and the steering collar flange bush plus thrust washer bronze bushings with AeroTough. Also included in this kit are the small over-centre lock assembly bushings. The objective is to eliminate all lubrication of the Aerostar nose gear except for the two flange bushings at the end of the steering cylinder piston rod. Apart from the obvious benefit of not needing to grease these points, there's also the challenge of accessing the grease zerks. We replace the larger zerk fittings on the fuselage bosses with stainless steel taper threaded plugs so no future owner will try to grease fittings that are in a blind hole.

Benefits

- ✔ No need to grease any part of the nose gear during the annual inspection.
- ✔ Extremely long life: the MBA bushings may never require replacement during the life of the aircraft.
- ✔ Savings in aircraft empty weight.
- ✔ No mess from excess grease in the nose box.



Wiebel NLG Bushing Kit

Product Name	Product Number	Price	Approved Models
Aerostar Wiebel NLG Bushing Kit	M1012	\$2,310.00 USD	600, 601, 601P, 602P, 700P

Prices subject to change without notice.

Approvals

TCCA STC No. SA14-43, FAA STC No. SA03484NY

Contents

MBA Part #	Description	Quantity	OEM Cross Reference Part #
MBA10028	Airframe Trunnion Bushing	2	920002-505
MBA10038	Drag Brace Connector Bushing	4	NAS77-A8-20
MBA10054	NWS Collar	1	450518-001
MBA10034	Upper Member Bushing	4	553-500
MBA10035	Upper & Lower Member Mandrel	2	450575-001

Wiebel NLG Oleo Kit

FAA and TCCA Approved

Reduces Maintenance Costs and Downtime

Overview

This kit covers the pneumatic/hydraulic elements in the strut. The heavy bronze lower bush is replaced with an AeroTough® element containing the polymer lip seal replacing an O-ring. The wiper is a polymer ring replacing the metal scraper. The OD seal is a conventional O-ring with 2 back-up rings. The V-seal and wiper are held in place by the hat section lower metal cover. The lower thrust washer beneath the steering collar has recently been added, making the steering collar mechanism totally self-lubricating.

The floating piston with its two opposing V-seals was recently added to the kit. We have not included the upper centering cam; it remains bronze.

Benefits

- ✓ Eliminating the need for greasing any part of the nose gear ensures no joint is missed, providing peace of mind for the owner.
- ✓ The lip seal eliminates the possibility of a flat strut.
- ✓ The polymer wiper has less tendency to scratch the piston.
- ✓ The floating piston comes with the seals pre-fitted.



Wiebel NLG Oleo Kit

Product Name	Product Number	Price	Approved Models
Aerostar Wiebel NLG Oleo Kit	M1010	\$2,452. ⁰⁰ USD	600, 601, 601P, 602P, 700P

Prices subject to change without notice.

Approvals

TCCA STC No. SA14-43, FAA STC No. SA03484NY

Contents

MBA Part #	Description	Quantity	OEM Cross Reference Part #
MBA10101	Gland	1	450512-001
MS28774-148	Back-up ring	2	MS28774-148
MS28775-148	O-ring	1	MS28775-148
MBA10122	Wiper Seal	1	MS28776-22
MBA10121	Gland Seal	1	MS28775-330 (qty.1), MS28782-33 (qty.2)
MBA10100	Floating Piston	1	450513-501
MBA10095	Floating Piston Seal	2	MS28775-325

Wiebel NLG Torque Link Kit

FAA and TCCA Approved

Eliminate nose gear torque link play by replacing all bronze bushings with self-lubricating AeroTough®

Overview

Nosewheel shimmy can be caused by excessive clearance in the torque link bearing points. The OEM needle zerks are difficult to grease effectively and when grease doesn't get to where it's needed, the bushings wear. It's also messy and high-pressure water cleaning can cause even more problems by inducing corrosion on the pins.

The Marsh Brothers kit addresses the link joint lost motion risk and cleans up the mess of leaked grease.

Once the MBA bushings have been installed, the needle zerks can be removed and replaced by MBA supplied plastic buttons, blocking each hole from anyone trying to grease a hole that leads nowhere.

Benefits

- ✓ No maintenance. No greasing required.
- ✓ Self-lubricating. Eliminate 6 greasing points.
- ✓ No grease to attract dust and dirt.
- ✓ No grease to be washed out when flying in rain.
- ✓ Clean; improves aesthetic appearance.



Wiebel NLG Torque Link Kit

Product Name	Product Number	Price	Approved Models
Aerostar Wiebel NLG Torque Link Kit	M1011	\$1,502. ⁰⁰ USD	600, 601, 601P, 602P, 700P

Prices subject to change without notice.

Approvals

TCCA STC No. SA14-43, FAA STC No. SA03484NY

Contents

MBA Part #	Description	Quantity	OEM Cross Reference Part #
MBA10031	Upper & Lower Torque Link Bushing	4	450534-001
MBA10032	Upper Connector Bushing	2	450535-001
MBA10033	Lower Connector Bushing	2	450535-501

Control Knob Kit

A Better Grip for Superior Performance

Overview

Marsh Brothers' control knobs for Aerostars also known as fuel mixture knobs are easier to get your fingers around than the stock plastic knobs.

Setting mixtures at altitude takes some finesse and these knobs make the job easier.

You do it with two fingers and your thumb, and it just feels 'right'.

Benefits

- ✓ Easy to set fuel burn.
- ✓ Feels better than stock plastic.
- ✓ Easy to install: Takes only 5 minutes to install both.
- ✓ Hardware provided.

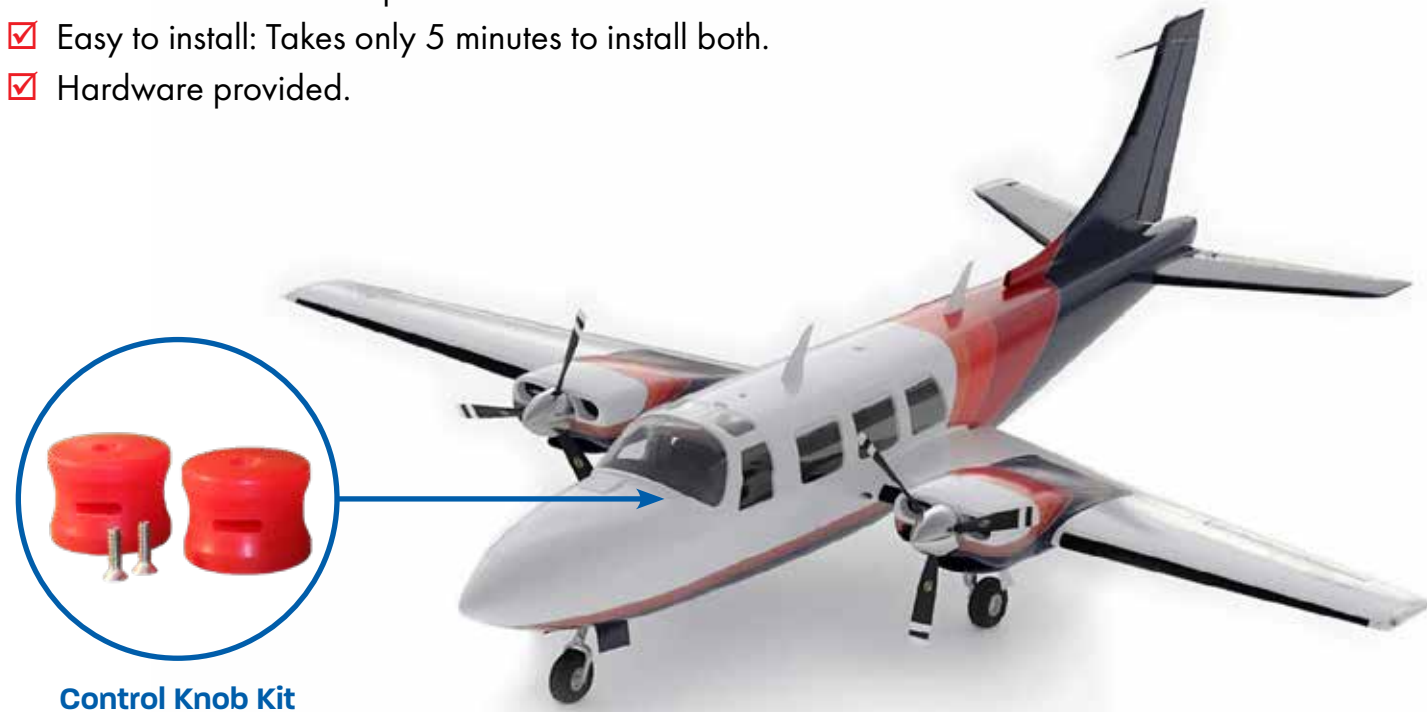

Control Knob Kit

Product Name	Product Number	Price	Approved Models
Aerostar Control Knob Kit	M1035	\$160.00 USD	600, 601, 601P, 602P, 700P

Prices subject to change without notice.

Contents

MBA Part #	Description	Quantity
MBA10146-1	Knob, Fuel Mixture (Red)	2
MS51959-31	Flat Head Machine Screw #6-32 5/8	2

Typical Installation

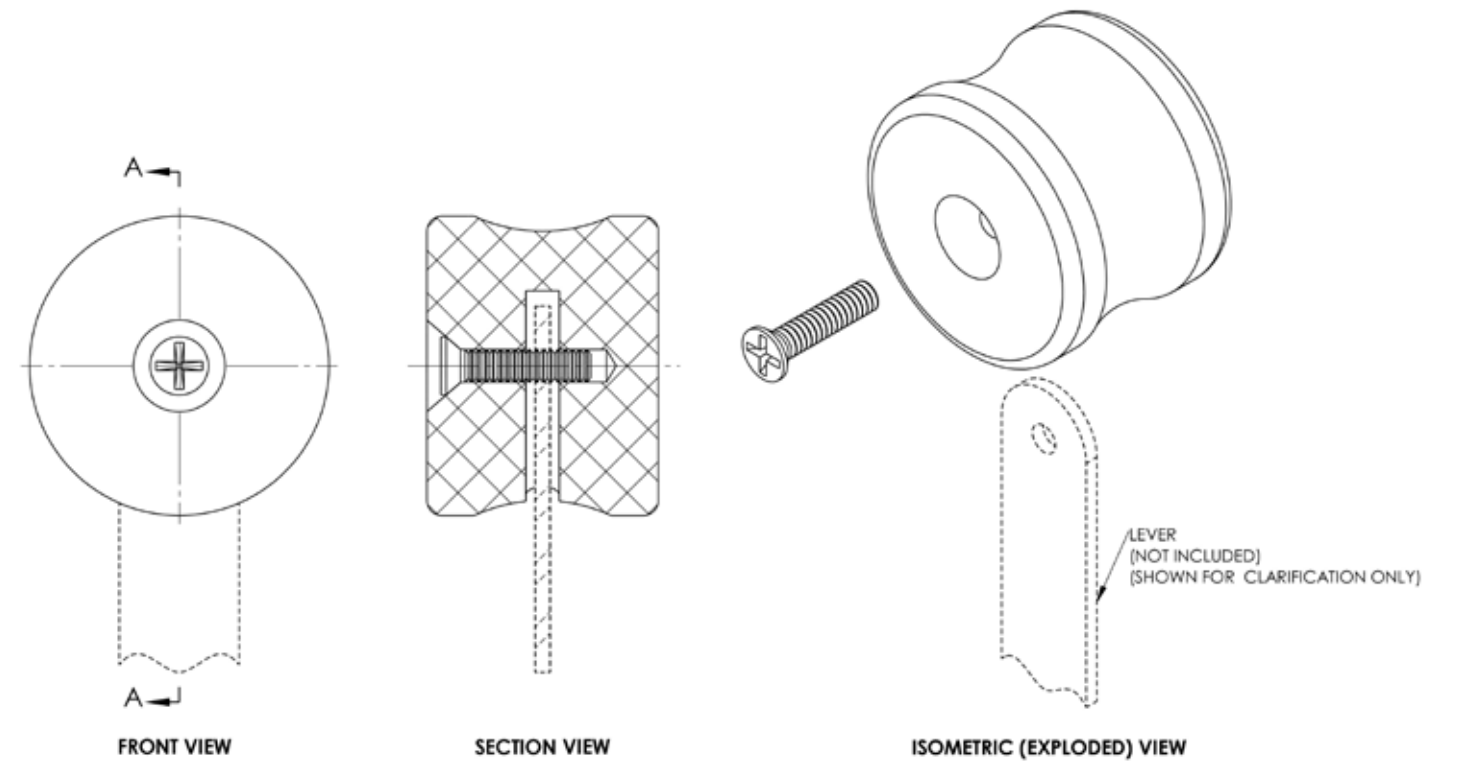

Fuel Selector Knobs

Improved Visualization with Indicator Line

Overview

The ability to quickly sweep the instrument panel and visually determine its status is a vital aspect of safe aircraft operation. With the existing fuel selector knobs being all black, it can be difficult to read their setting on a black background.

Marsh Brothers' Fuel Selector Knobs incorporate a bright white indicator line providing a precise and quick visual reference of actual position.

These Fuel Selector Knobs enhance the ability to quickly determine fuel panel status at a glance, and they are also easy to install with no additional hardware. Just push them on and go.

Benefits

- ✔ Better and quicker visual indication of position at a glance.
- ✔ Easy to install: All mounting hardware provided.
- ✔ Durable and long lasting.



Fuel Selector Knobs

Product Name	Product Number	Price	Approved Models
Aerostar Fuel Selector Knobs	M1021	\$62. ⁰⁰ USD	600, 601, 601P, 602P, 700P

Prices subject to change without notice.

Contents

MBA Part #	Description	Quantity
M1021	Aerostar Fuel Selector Knobs	2

FAQ

Question: Do I need any extra hardware to install these fuel selector knobs?

Answer: No. The Marsh Brothers knobs come fitted with a metal insert that installs onto the rotary switch shaft and a retaining set screw.

To install the Marsh Brothers knobs:

1. Remove the OEM knob.
2. Back out the retaining set screw.
3. Insert the new knob onto the switch shaft and align it to the position that the OEM knob was removed from.
4. Tighten the retaining set screw.



Landing Gear Handle Knob Kit

Available in Blue or White

Increase the Positive Feeling of Gear Up & Gear Down

Overview

The OEM landing gear handle knob is too small. Marsh Brothers' handle knob feels more substantial than OEM knob and is easy to fit to most models.

These knobs are 1.3" (33mm) in diameter and have a width of 0.8" (20mm).

Remove the stock knob to ensure there will be enough clearance for this one before you order.

Benefits

- ✓ Positive feel when selecting gear.
- ✓ Provides a better grip.
- ✓ Will last longer than your airplane.



Landing Gear Handle Knob Kit

Product Name	Product Number	Price	Approved Models
Aerostar Landing Gear Handle Knob (Blue)	M-01-10000-1	\$112.00 USD	600, 601, 601P,
Aerostar Landing Gear Handle Knob (White)	M-01-10000-3	\$112.00 USD	602P, 700P

Prices subject to change without notice.

Contents

MBA Part #	Description	Quantity
M-01-10000-1	Landing Gear Handle Knob (Blue)	1
M-01-10000-3	Landing Gear Handle Knob (White)	1

Typical Installation

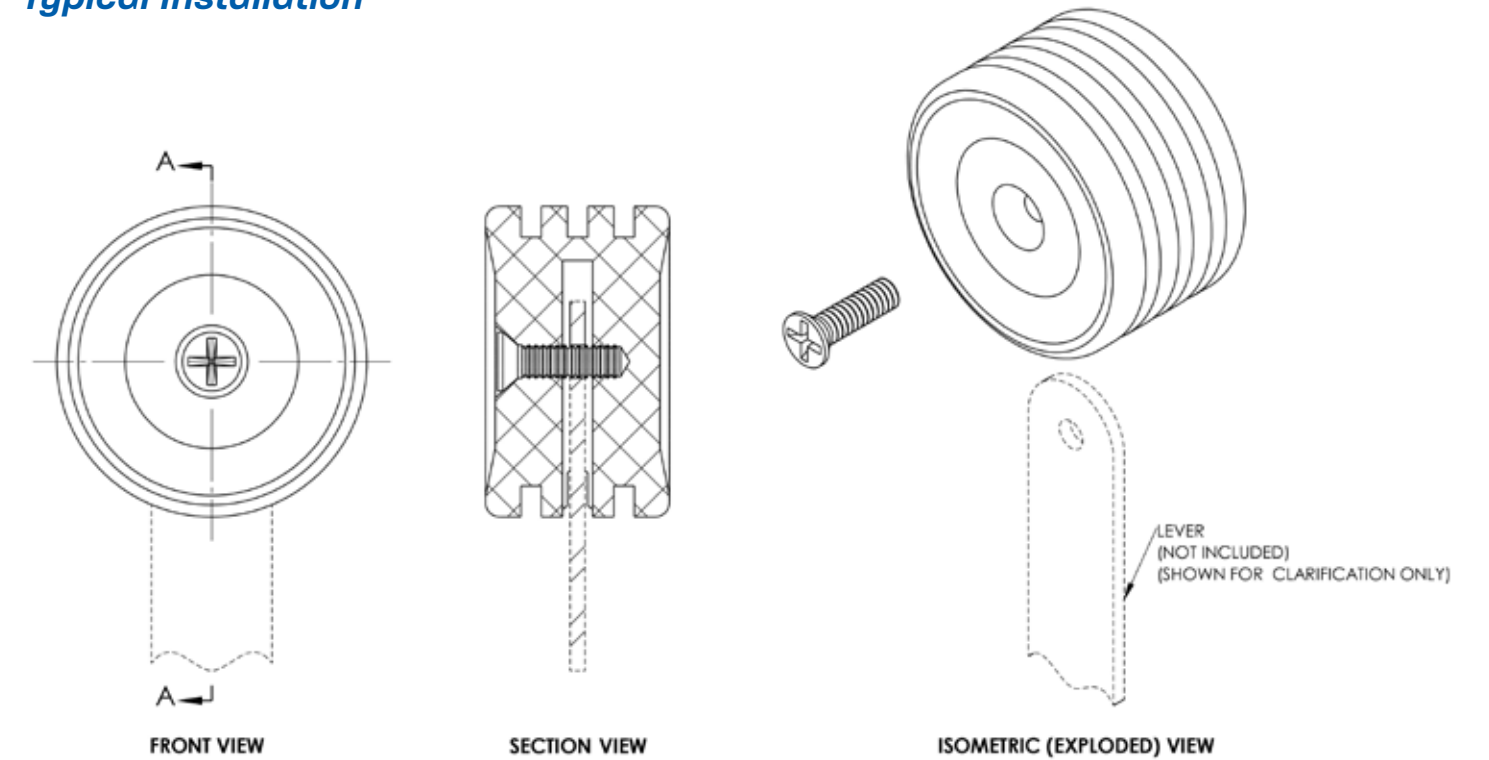

Seat Roller Repair Sleeve & Bushing Kit

Complies with Chapter 25 of the Maintenance Manual

Repair worn or corroded seal rollers assembly in accordance with AMM provisions.

Repair Aluminum Seat Rollers Instead of Replacing Them

Overview

Seats in the Aerostar are designed to roll on four aluminum rollers located at each seat corner. The rollers are made from a relatively soft aluminum running against steel sleeves, and are not supposed to be lubricated in accordance with the aircraft maintenance requirements. If the wear is uneven across the four rollers, the worn roller will not be able to support the seat which can cause the seat to bind making it difficult to move forward and backward.

Marsh Brothers' AeroTough® bushings are made of a self-lubricating polymer that is designed to repair wear on the internal diameter of the aluminum seat rollers, while at the same time providing a self-lubricating non-metallic liner to prevent future wear of the aluminum roller bore by eliminating metal-to-metal contact.

Additionally, should the OEM steel sleeves become corroded, Marsh Brothers offer replacements made from corrosion-resistant steel.

Installation Note: Your existing rollers need to be bored to accept the AeroTough® GF (Grease-Free) bushings. The best way is with a drill in the tailstock of a lathe; you're assured concentricity.

If you're using EZ-Glide "T"-bars, adjust them with weight on the seat so they float in the rails. They should not touch the upper or lower surfaces.

Benefits

- ✓ Repair aluminum seat rollers instead of replacing them.
- ✓ Upgrade OEM seat rollers with self-lubricating polymer to prevent further future wear.
- ✓ Upgrade OEM steel sleeves with corrosion resistant steel.
- ✓ Easy to install.
- ✓ Long lasting.

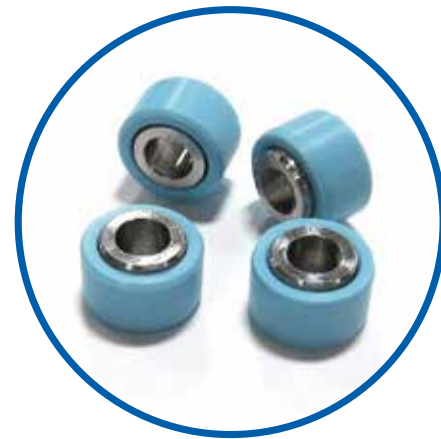

Seat Roller Repair Sleeve & Bushing Kit

Note: The bushing kit and the stainless-steel sleeve kit are sold separately.

Product Name	Product Number	Price	Approved Models
Aerostar Seat Roller Repair Bushing Kit	M-01-1001	\$149. ⁰⁰ USD	600, 601, 601P, 602P, 700P
Aerostar Seat Roller Repair Sleeve Kit	M-01-1002	\$176. ⁰⁰ USD	

Prices subject to change without notice.

Contents

MBA Part #	Description	Quantity
M-01-1001	Seat Roller Repair Bushing Kit	4
M-01-1002	Seat Roller Repair Sleeve Kit	4

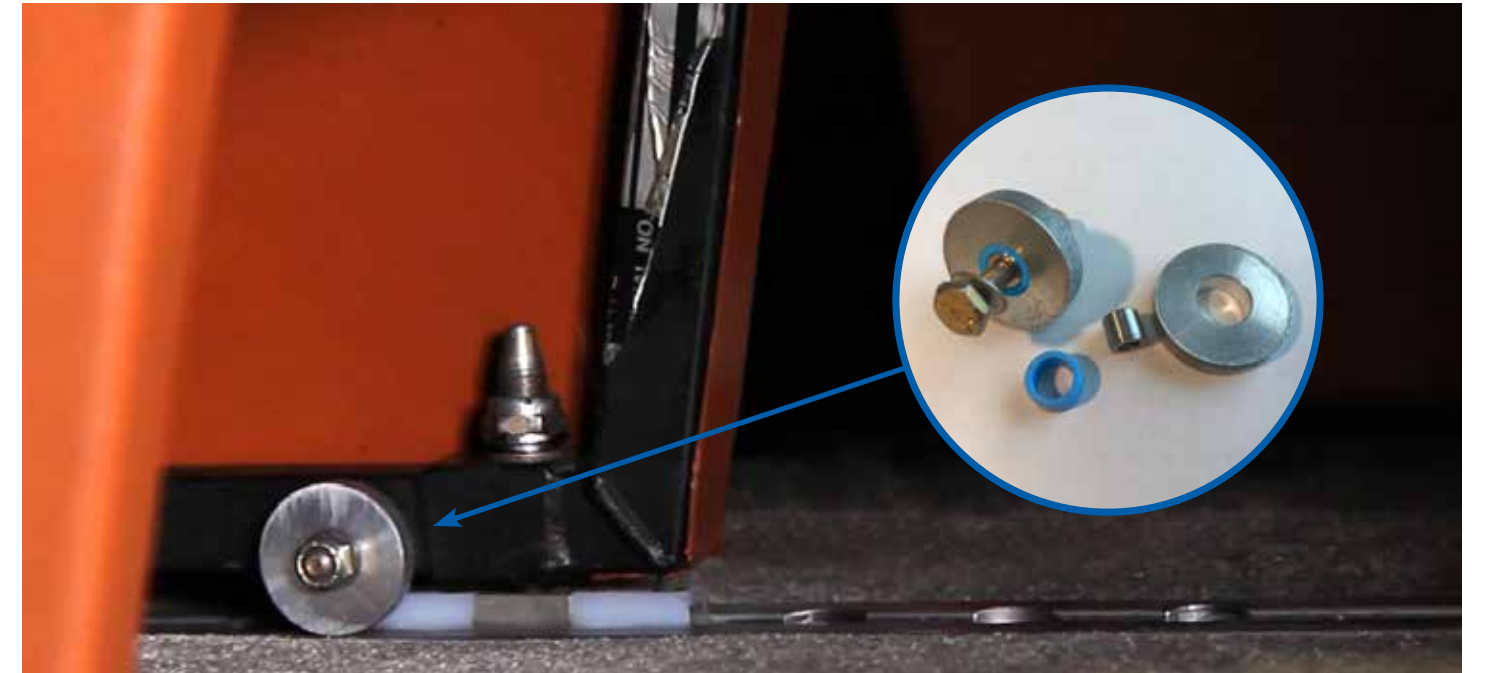

Aerostar Seat Stopper

Prevent Aft Movement of Seat in Flight

Overview

Marsh Brothers' Seat Stopper was designed to prevent inadvertent aft movement of the pilot and co-pilot seat should the seal locking mechanism fail or become disengaged. This is especially important during critical phases of flight such as during takeoff and landing.

The Marsh Brothers Seat Stopper will work with seats outfitted with the EZ-glide conversion and is compatible with the 210078 seat track or equivalent.

Once your seat is positioned, easily insert the Seat Stopper in the seat track detent immediately behind the seat base before flight to secure pilot and co-pilot seats and prevent any aft movement if the seat lock fails. This Seat Stopper is effective in all flight conditions and in turbulence. The O-ring is sized to ensure a snug fit in the seat track.

It's easy to reach back, insert and remove from the seat track when you're seated.

Benefits

- Added safety of a secondary seat positioning.
- Easy to use: Simply insert into the seat track detent adjacent to the rear of the seat base.
- Durable and long lasting.



Aerostar Seat Stopper

Note: Seat shown is equipped with the EZ Glide conversion.

Product Name	Product Number	Price	Approved Models
Aerostar Seat Stopper	M1014	\$115.00 USD	600, 601, 601P, 602P, 700P

Prices subject to change without notice.

Contents

MBA Part #	Description	Quantity
M1014	Aerostar Seat Stopper	1



Throttle Knob Kit (Black)

Superior Grip with Precise Power Control

Overview

Marsh Brothers Aviation's Throttle Knobs for Aerostar aircraft were designed to fit your hand for easy, precise power control. Since every pilot spends time making fine adjustments with manifold pressure, these knobs were designed to make this easier. Many pilots have reported that our Throttle Knobs have a "jet-like feel".

They are made from a proprietary polymer material that will never crack or break.

Benefits

- ✓ Superior grip with a jet-like feel.
- ✓ Easier to make fine adjustments to manifold pressure.
- ✓ Precise power control.
- ✓ Easy to install: All mounting hardware provided.
- ✓ Durable and long lasting. Will never crack or break.



Throttle Knob Kit

Product Name	Product Number	Price	Approved Models
Aerostar Throttle Knob Kit	M1015-3	\$160.00 USD	600, 601, 601P, 602P, 700P

Prices subject to change without notice.

Contents

MBA Part #	Description	Quantity
MBA10067B	Throttle Knobs	2
MS51957-34	Philips Pan Head Screws	2
AN960C6	Washers	2

Throttle Knob Profile:

Note: If your aircraft can use this configuration of a throttle knob, then this kit is for you.

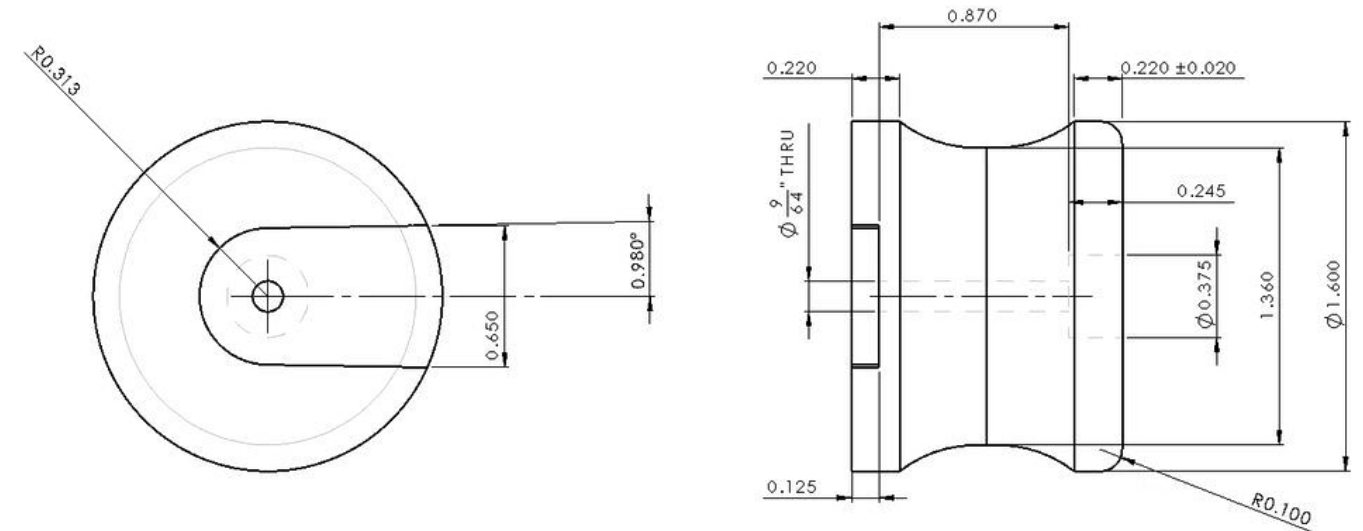

AeroTough® GF Fuel Cap Washers

FAA, TCCA and EASA Approved

Avoid the hassle of difficult to open and close fuel caps.
An easier way.

Overview

Installing Marsh Brothers' Non-Metallic AeroTough® GF (Grease-Free) Fuel Cap Washers will ensure your fuel cap remains safe and functional, making opening and closing much easier. The washer which is CNC machined to exact shape is made from a polymer produced by Marsh Brothers' parent company and is not available commercially from any other source. It has extraordinary toughness and wear resistance. The friction is four times lower than steel on steel making the cap much easier to open and close.

Benefits

- ☑ Consistent open/close force required to operate the fuel cap locking tab.
- ☑ A smooth operation of the fuel cap locking tab.
- ☑ Long wear life.

"They Work! I did not expect a bit of polymer to be worth 90 bucks but I was wrong. It is hard to believe the improvement they bring to the gas cap. They are more than worth the price. You have to turn it to believe it."



Parker Aerospace / Shaw Aero AeroTough® Fuel Cap Washers

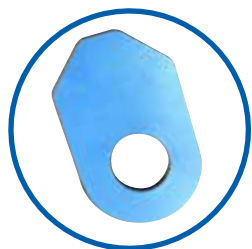

Gabb AeroTough® Fuel Cap Washers

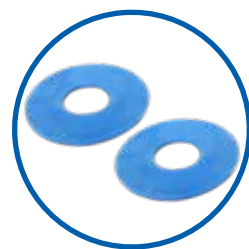

Parker Aerospace / Shaw Aero AeroTough® Fuel Cap Washers



Approved Models

Parts Design Approval No. PDA19-19

Fuel Cap			Aircraft Model Applicability	Package Quantity	Product Number	Price
Manufacturer	Model	P/N				
Gabb Special Products	N/A	37810-1	Textron Aviation: Baron Series, Bonanza Series, King Air 90 Series	Single	M-00-1001-1	\$79.00 USD
				Package of 2	M-00-1001-2	\$122.00 USD
				Package of 3	M-00-1001-3	\$162.00 USD
				Package of 4	M-00-1001-4	\$197.00 USD
	N/A	38339	King Air Series, 99 Series	Single	M-00-1002-1	\$79.00 USD
				Package of 2	M-00-1002-2	\$122.00 USD
				Package of 3	M-00-1002-3	\$162.00 USD
				Package of 4	M-00-1002-4	\$197.00 USD
Shaw Aero Device	416 Series	416-50 416-85	Textron Aviation: Baron Series, Bonanza Series	Single	M-00-1000-1	\$79.00 USD
				Package of 2	M-00-1000-2	\$122.00 USD
				Package of 3	M-00-1000-3	\$162.00 USD
				Package of 4	M-00-1000-4	\$197.00 USD
	431 Series	431-9	Textron Aviation: Baron Series, Bonanza Series, King Air 90 Series	Single	M-00-1000-1	\$79.00 USD
				Package of 2	M-00-1000-2	\$122.00 USD
				Package of 3	M-00-1000-3	\$162.00 USD
				Package of 4	M-00-1000-4	\$197.00 USD
	457 Series	457-113 457-115 457-116 457-370	Textron Aviation: Baron Series, Bonanza Series, King Air Series, 1900 Series, 99 Series	Single	M-00-1000-1	\$79.00 USD
				Package of 2	M-00-1000-2	\$122.00 USD
				Package of 3	M-00-1000-3	\$162.00 USD
				Package of 4	M-00-1000-4	\$197.00 USD
531 Series	531-001 531-033 531-046 531-035	Textron Aviation: Baron Series, Bonanza Series, Aerostar Aircraft Corporation: Aerostar Series	Single	M-00-1000-1	\$79.00 USD	
			Package of 2	M-00-1000-2	\$122.00 USD	
			Package of 3	M-00-1000-3	\$162.00 USD	
			Package of 4	M-00-1000-4	\$197.00 USD	
Parker Aerospace	416 Series	416-50	Textron Aviation: Baron Series, Bonanza Series	Single	M-00-1000-1	\$79.00 USD
				Package of 2	M-00-1000-2	\$122.00 USD
				Package of 3	M-00-1000-3	\$162.00 USD
				Package of 4	M-00-1000-4	\$197.00 USD
Parker/Shaw	N/A	39051-3	Textron Aviation: King Air Series	Single	M-04-1001-1	\$103.00 USD
				Package of 2	M-04-1001-2	\$168.00 USD
				Package of 3	M-04-1001-3	\$208.00 USD
				Package of 4	M-04-1001-4	\$243.00 USD

Prices subject to change without notice.

Hydraulic Accumulator Piston-Seal Kit

Available for Hydrodyne and York Industries model hydraulic accumulators.

FAA and TCCA Approved

Reduce the risk of bore scratches and stuck pistons with a Non-Metallic AeroTough® Piston

Overview

We've replaced an aluminum piston sealed with O-rings with a non-metallic piston incorporating two back-to-back V-ring seals. The accumulator will work trouble-free for years, but once the bore gets scratched from dirt or metallic particles, leakage is inevitable. Honing out the scratches is not easy but essential. The MBA kit eliminates the risk of metal on metal contact. We supply a "shoe-horn" made from Nylon to guide the piston into the cylinder and prevent damage from sharp threads.

Benefits

- ✓ Eliminate the possibility of metal-to-metal contact & typical O-ring failure modes.
- ✓ Simple & easy to install: Reduced part count and the piston is shipped with the seals pre-installed and a seal compression tool is provided with each kit.
- ✓ Durable and long lasting.

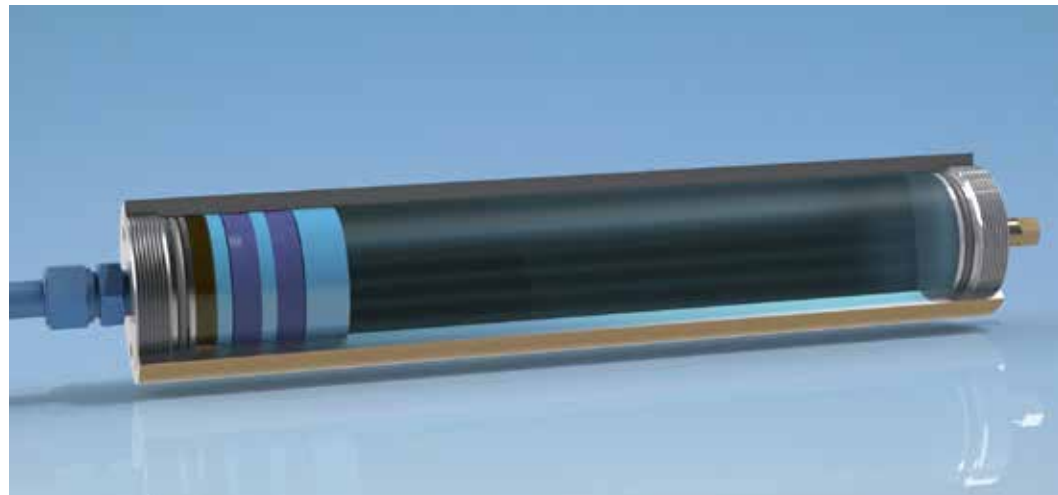

Hydraulic Accumulator
Piston-Seal Kit

Product Name	Product Num.	Price	Approved Models
Aerostar Hydraulic Accumulator (Hydrodyne)	M1030	\$692.00 USD	600, 601,
Aerostar Hydraulic Accumulator (York)	M1031	\$692.00 USD	601P, 602P, 700P

Prices subject to change without notice.

Approvals:

TCCA STC No. SA17-96, FAA STC No. SA04060NY

Contents

MBA Part #	Description	Quantity
M1030	Aerostar Hydraulic Accumulator (Hydrodyne)	1
M1031	Aerostar Hydraulic Accumulator (York)	1



***I have installed two kits
and both are working great.
No more nitrogen charge leaking down.
No more intermittent piston sticking.***

-D. Smith



Polymer Spinner Washers

MBA spinner washers are designed to last for the life of the airplane

Overview

MBA spinner washers are CNC machined from a flexible polymer, not stamped from a sheet of Nylon.

The screw hole is sized so they need to be twisted on to the 10/32 screw. You'll find they'll outlast the screw. And, your mechanics won't lose them when they remove the screws during your annual inspection.

These washers are designed to assume the flat shape of the screw head on the outer surface and match the curvature of the spinner on the inside. They won't put any stress on the aluminum spinner trying to flatten it where it's supposed to be round.

Benefits

- ☑ We believe these washers will reduce or eliminate the tendency for spinners to crack.
- ☑ These washers can express your personality; like the red brake calipers on your car. If you're one who likes to show you value quality, pick yellow. If you prefer not to stand out in a crowd, pick clear. Grey is for conservatives who want to be sure they're still in place.



Grey

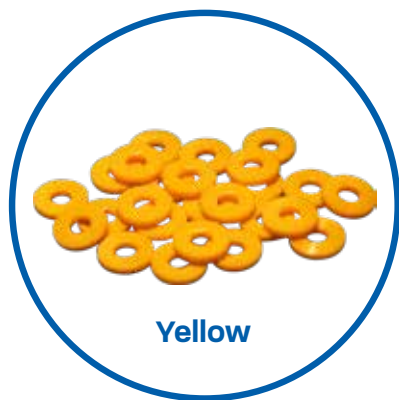

Yellow



Clear

Spinner Washers

Contents

MBA Part #	Description	Quantity	Price
M1020-5	Polymer Spinner Washers (Yellow)	5	\$19.00 USD
M1020-10	Polymer Spinner Washers (Yellow)	10	\$40.00 USD
M1020-25	Polymer Spinner Washers (Yellow)	25	\$108.00 USD
M1026-5	Polymer Spinner Washers (Grey)	5	\$19.00 USD
M1026-10	Polymer Spinner Washers (Grey)	10	\$40.00 USD
M1026-25	Polymer Spinner Washers (Grey)	25	\$108.00 USD
M1027-5	Polymer Spinner Washers (Clear)	5	\$19.00 USD
M1027-10	Polymer Spinner Washers (Clear)	10	\$40.00 USD
M1027-25	Polymer Spinner Washers (Clear)	25	\$108.00 USD

Prices subject to change without notice.



Cleveland Brake Master Cylinder Upgrade/Repair Kit

FAA, TCCA and EASA Approved

Stop leaks around the piston rod with a better seal

Overview

You can rebuild your brake master cylinders because they're leaking or you can take a proactive approach and rebuild them before they leak, because in time, they will leak.

The biggest problem area is the piston rod to gland seal. The MBA kit replaces both the gland and changes the type of seal. The metal gland is replaced with a non-metallic gland of AeroTough® and the O-ring seal gives way to a V-ring polymer seal that won't leak no matter how cold the airplane gets sitting on the ramp.

All other parts in the kit are included to bring the cylinder up to better-than-new condition. The seal expansion bullet is just used during assembly to keep the piston rod threads from damaging the inner seal lip.

Just like struts that leak only when the airplane is very cold, the same can happen with the master cylinders and while the leak will likely stop once the cabin warms up, there's now a sticky mess around the brake pedal.

Benefits

- ✓ Avoid scratching the piston rod if dirt gets trapped between gland and rod.
- ✓ Don't buy a new cylinder; fix yours and make it better than new.
- ✓ Easy to install, typically completed in 1 hour.
- ✓ Fix it before it breaks.



Product Name	Product Num.	Price	Approved Models
Aerostar Aircraft Corp	M-00-1003-1	\$198.00 USD	See Following Page.

Approvals:

TCCA RDA No. C-RA22-016D

Approved Models:

Aerostar Models.

Piper PA-60-600, PA-60-601, PA-60-601P, Piper Aerostar PA60 602P, PA60 700P

OEM Brake Master Cylinder P/N			
M-Kit	Aerostar Aircraft Corp.	Mooney	Cirrus Design Corp.
M-00-1003-1	980014-001 (MFG P/N: 10-24C)	10-24D	14269-001 (MFG P/N: 10-24C)

Item #	MBA Part #	Description	QTY	OEM Cross Reference Part #
1	MS16625-4081	Internal Retaining Ring	1	155-01200
2	MBA-01-10025	Spring Seat/Wiper Washer	1	095-01300
3	MS28775-113	O-Ring (Piston Head, Gland Static)	1	MS28775-113
4	MBA-01-10021	Lip Seal (Piston Rod, Dynamic)	1	MS28775-012
5	MBA-01-10022	End Gland	1	141-01200
6	MS28775-006	O-Ring (Piston Head Bypass)	1	MS28775-006
7	T5304-015	Snap Ring	1	155-04800
8	MS35333-40	Star Lock Washer	1	MS35333-40
9	AN316-4	Nut	1	AN316-4
10	AN960-616L	Flat Washer	1	AN960-616L

Caution: Piston Rod Lip Seal is made from Marsh Brothers proprietary material known as AeroLas™-Flex which is not compatible with phosphate ester hydraulic fluid, commercially known as Skydrol. Exposure to this fluid contamination will damage the seal.

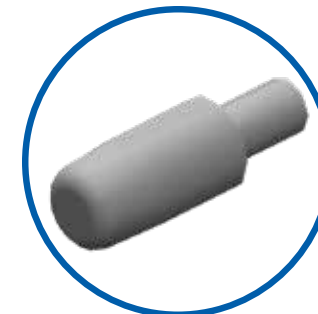

Seal Expansion Bullet
(included with kit)

See Installation Instructions for more information.

Engine Cowl Anti-Chafing Liner

Designed to Protect the Upper Engine Cowl from Chafing Damage

Overview

Marsh Brothers' Aerostar Engine Cowl Anti-Chafing Liner Kit (Chafe Protection) provides protection of the interior surface of the engine cowl where the engine airframe seals contact with the upper engine cowling assembly.

By providing a tough abrasion resistant surface made from Marsh Brothers' proprietary material AeroLas-White, wear on the aluminum upper engine cowl is eliminated.

Unlike most other chafe protection material available our anti-chafing liners do not have an adhesive backing. Instead, they are bonded in place using 3M DP420 two-part epoxy (not included in the kit). This results in a significantly stronger bond.

Features

- ☑ Anti-chafing liners are sized to fit approximately, only minor trimming may be required. See installation instructions on our website for more information.
- ☑ Anti-chafing liners are made of AeroLas-White, our flexible, tough, and abrasion resistant self-lubricating polymer. Visit our website for more information on AeroLas-White material.



Product Name	Product Num.	Price	Approved Models
Aerostar Engine Cowl Anti-Chafing Liner	M-1036-3	\$119. ⁰⁰ USD	600, 601, 601P, 602P, 700P

Approvals:

NA

Contents

MBA Part #	Description	QTY
M-1036-3	Aerostar Engine Cowl Anti-Chafing Liner	4

Note: 1 kit does 1 engine cowl. A full shipset is 2 kits.

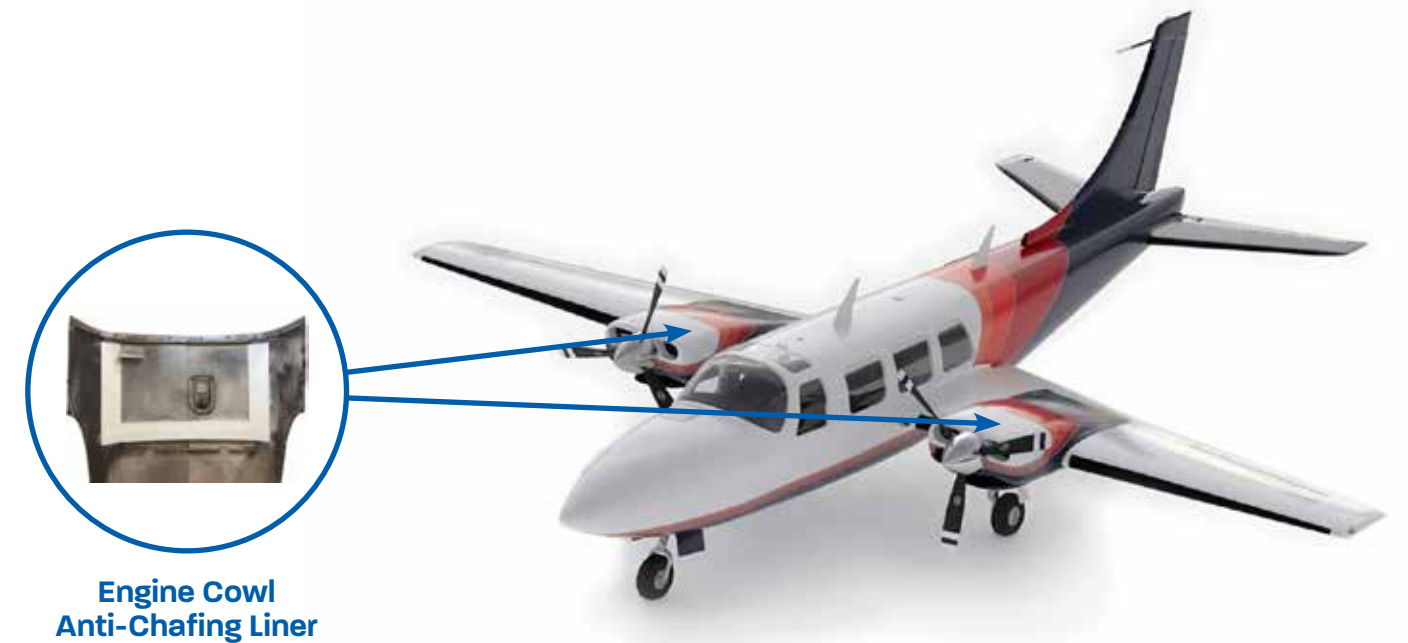

Engine Cowl Anti-Chafing Liner

Turbo Cross-Shaft Bearing Block Kit

FAA, TCCA and EASA Approved

Reduce Maintenance Costs and Pilot Workload

Overview

The MBA Aerostar Turbo Cross-Shaft (TCS) Bearing Block Kit is designed to save time and reduce maintenance with long-life polymer bearings. These advanced technology bearings eliminate premature wear of the cross-shaft and last longer than the OEM solution.

Exhaust pressure pulses from the engine cause oscillations at the turbo's wastegate butterfly resulting in vibration at the cross-shaft bearing blocks and lead to premature wear of the bearings and end shafts.

With high-temperature self-lubricating polymer bearings securely carrying the turbo cross-shaft at both ends, without the need for any lubrication, premature wear is eliminated and variations in manifold pressure, due to lost motion, are reduced.

Benefits

An essential part of the Aerostar engine, the proper functioning of the turbo cross-shaft is critical. Marsh Brothers' new Aerostar TCS Bearing Block Kit helps resolve costly maintenance issues and lasts longer than the metal bearings through the use of revolutionary design and self-lubricating polymer bearings.

- ✓ **Saves Time** – The MBA Aerostar TCS Kit reduces a pilot's need to actively manage the manifold pressures, through the throttle levers, by eliminating worn cross-shaft bearings.
- ✓ **Reduces Maintenance** – due to its self-lubricating and high-temperature cross shaft bearings, which last more than 3x the OEM metal bearings, the MBA Aerostar TCS Bearing Kit reduces aircraft lifecycle maintenance costs.
- ✓ **All-in-One Kit** – The MBA Aerostar TCS Bearing Block Kit is all that is needed for one Aerostar engine. No additional components are required.
- ✓ **Longer Life** – Based on field trials, the MBA repair kit should last at least 3x longer than the OEM metal bearing.



Product Name	Product Num.	Price	Approved Models
Turbo Cross-Shaft Bearing Block Kit	M-01-1004-1	\$1,854. ⁰⁰ USD	601P, 602P, 700P

Approvals:

TCCA RDA C-RA23-041/D

Approved Models:

Aerostar Models.

Piper PA-60-601P, Piper Aerostar PA60 602P, PA60 700P

Contents

Kit Components:

Item #	MBA Part #	Description	QTY	OEM Cross Reference Part #
1	MB-01-10002-1	ATHT Polymer Bearing Block (INBOARD/LONG)	1	300037-001/-505
2	MB-01-10002-2	ATHT Polymer Bearing Block (OUTBOARD/SHORT)	1	300037-501/-503
3	MB-01-10012-1	End Shaft	2	N/A
4	MS21045-4	Nut	2	MS21045-4

Additional Required Components NOT Included in the Kit:

Item #	MBA Part #	Description	QTY	OEM Cross Reference Part #
Add-on	N/A	Cross Shaft with separate ends	N/A	300035-527



Turbo Cross-Shaft Bearing Block Kit

Mooney Products Overview



AeroTough® GF Fuel Cap Washers

FAA, TCCA and EASA Approved

Avoid the hassle of difficult to open and close fuel caps.
An easier way.

Overview

Installing Marsh Brothers' Non-Metallic AeroTough® GF (Grease-Free) Fuel Cap Washers will ensure your fuel cap remains safe and functional, making opening and closing much easier. The washer which is CNC machined to exact shape is made from a polymer produced by Marsh Brothers' parent company and is not available commercially from any other source. It has extraordinary toughness and wear resistance. The friction is four times lower than steel on steel making the cap much easier to open and close.

Benefits

- ☑ Consistent open/close force required to operate the fuel cap locking tab.
- ☑ A smooth operation of the fuel cap locking tab.
- ☑ Long wear life.

"They Work! I did not expect a bit of polymer to be worth 90 bucks but I was wrong. It is hard to believe the improvement they bring to the gas cap. They are more than worth the price. You have to turn it to believe it."



Parker Aerospace / Shaw Aero AeroTough® Fuel Cap Washers

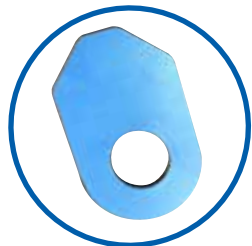

Gabb AeroTough® Fuel Cap Washers

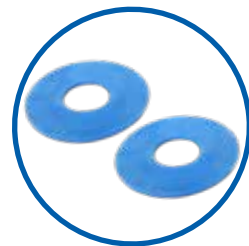

Parker Aerospace / Shaw Aero AeroTough® Fuel Cap Washers



Approved Models

Parts Design Approval No. PDA19-19

Fuel Cap			Aircraft Model Applicability	Package Quantity	Product Number	Price
Manufacturer	Model	P/N				
Gabb Special Products	N/A	37810-1	Textron Aviation: Baron Series, Bonanza Series, King Air 90 Series	Single	M-00-1001-1	\$79.00 USD
				Package of 2	M-00-1001-2	\$122.00 USD
				Package of 3	M-00-1001-3	\$162.00 USD
				Package of 4	M-00-1001-4	\$197.00 USD
	N/A	38339	King Air Series, 99 Series	Single	M-00-1002-1	\$79.00 USD
				Package of 2	M-00-1002-2	\$122.00 USD
				Package of 3	M-00-1002-3	\$162.00 USD
				Package of 4	M-00-1002-4	\$197.00 USD
Shaw Aero Device	416 Series	416-50 416-85	Textron Aviation: Baron Series, Bonanza Series	Single	M-00-1000-1	\$79.00 USD
				Package of 2	M-00-1000-2	\$122.00 USD
				Package of 3	M-00-1000-3	\$162.00 USD
				Package of 4	M-00-1000-4	\$197.00 USD
	431 Series	431-9	Textron Aviation: Baron Series, Bonanza Series, King Air 90 Series	Single	M-00-1000-1	\$79.00 USD
				Package of 2	M-00-1000-2	\$122.00 USD
				Package of 3	M-00-1000-3	\$162.00 USD
				Package of 4	M-00-1000-4	\$197.00 USD
	457 Series	457-113 457-115 457-116 457-370	Textron Aviation: Baron Series, Bonanza Series, King Air Series, 1900 Series, 99 Series	Single	M-00-1000-1	\$79.00 USD
				Package of 2	M-00-1000-2	\$122.00 USD
				Package of 3	M-00-1000-3	\$162.00 USD
				Package of 4	M-00-1000-4	\$197.00 USD
531 Series	531-001 531-033 531-046 531-035	Textron Aviation: Baron Series, Bonanza Series, Aerostar Aircraft Corporation: Aerostar Series	Single	M-00-1000-1	\$79.00 USD	
			Package of 2	M-00-1000-2	\$122.00 USD	
			Package of 3	M-00-1000-3	\$162.00 USD	
			Package of 4	M-00-1000-4	\$197.00 USD	
Parker Aerospace	416 Series	416-50	Textron Aviation: Baron Series, Bonanza Series	Single	M-00-1000-1	\$79.00 USD
				Package of 2	M-00-1000-2	\$122.00 USD
				Package of 3	M-00-1000-3	\$162.00 USD
				Package of 4	M-00-1000-4	\$197.00 USD
Parker/Shaw	N/A	39051-3	Textron Aviation: King Air Series	Single	M-04-1001-1	\$103.00 USD
				Package of 2	M-04-1001-2	\$168.00 USD
				Package of 3	M-04-1001-3	\$208.00 USD
				Package of 4	M-04-1001-4	\$243.00 USD

Prices subject to change without notice.

Polymer Spinner Washers

MBA spinner washers are designed to last for the life of the airplane

Overview

MBA spinner washers are CNC machined from a flexible polymer, not stamped from a sheet of Nylon.

The screw hole is sized so they need to be twisted on to the 10/32 screw. You'll find they'll outlast the screw. And, your mechanics won't lose them when they remove the screws during your annual inspection.

These washers are designed to assume the flat shape of the screw head on the outer surface and match the curvature of the spinner on the inside. They won't put any stress on the aluminum spinner trying to flatten it where it's supposed to be round.

Benefits

- ☑ We believe these washers will reduce or eliminate the tendency for spinners to crack.
- ☑ These washers can express your personality; like the red brake calipers on your car. If you're one who likes to show you value quality, pick yellow. If you prefer not to stand out in a crowd, pick clear. Grey is for conservatives who want to be sure they're still in place.



Grey

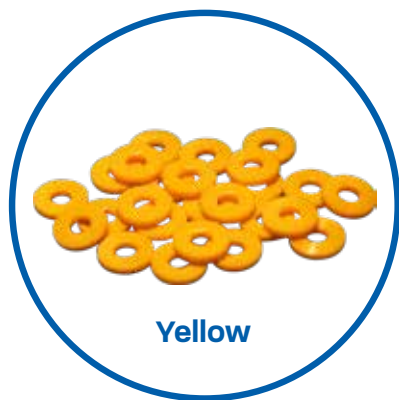

Yellow



Clear

Spinner Washers

Contents

MBA Part #	Description	Quantity	Price
M1020-5	Polymer Spinner Washers (Yellow)	5	\$19. ⁰⁰ USD
M1020-10	Polymer Spinner Washers (Yellow)	10	\$40. ⁰⁰ USD
M1020-25	Polymer Spinner Washers (Yellow)	25	\$108. ⁰⁰ USD
M1026-5	Polymer Spinner Washers (Grey)	5	\$19. ⁰⁰ USD
M1026-10	Polymer Spinner Washers (Grey)	10	\$40. ⁰⁰ USD
M1026-25	Polymer Spinner Washers (Grey)	25	\$108. ⁰⁰ USD
M1027-5	Polymer Spinner Washers (Clear)	5	\$19. ⁰⁰ USD
M1027-10	Polymer Spinner Washers (Clear)	10	\$40. ⁰⁰ USD
M1027-25	Polymer Spinner Washers (Clear)	25	\$108. ⁰⁰ USD

Prices subject to change without notice.



Cleveland Brake Master Cylinder Upgrade/Repair Kit

FAA, TCCA and EASA Approved

Stop leaks around the piston rod with a better seal

Overview

You can rebuild your brake master cylinders because they're leaking or you can take a proactive approach and rebuild them before they leak, because in time, they will leak.

The biggest problem area is the piston rod to gland seal. The MBA kit replaces both the gland and changes the type of seal. The metal gland is replaced with a non-metallic gland of AeroTough® and the OEM seal gives way to a V-ring polymer seal that won't leak no matter how cold the airplane gets sitting on the ramp.

All other parts in the kit are included to bring the cylinder up to better-than-new condition. The seal expansion bullet is just used during assembly to keep the piston rod threads from damaging the inner seal lip.

Just like struts that leak only when the airplane is very cold, the same can happen with the master cylinders and while the leak will likely stop once the cabin warms up, there's now a sticky mess around the brake pedal.

Benefits

- ✓ Avoid scratching the piston rod if dirt gets trapped between gland and rod.
- ✓ Don't buy a new cylinder; fix yours and make it better than new.
- ✓ Easy to install, typically completed in 1 hour.
- ✓ Fix it before it breaks.



Product Name	Product Num.	Price	Approved Models
Aerostar Aircraft Corp	M-00-1003-1	\$198.00 USD	See Following Page.

Approvals:

TCCA RDA No. C-RA22-016D

Approved Models:

Mooney Aircraft Corp.

M20, M20A, M20B, M20C, M20D, M20E, M20F, M20G, M20J, M20K, M20L, M20M, M20R, M20S, M20TN, M20U, M20V

OEM Brake Master Cylinder P/N			
M-Kit	Aerostar Aircraft Corp.	Mooney	Cirrus Design Corp.
M-00-1003-1	980014-001 (MFG P/N: 10-24C)	10-24D	14269-001 (MFG P/N: 10-24C)

Item #	MBA Part #	Description	QTY	OEM Cross Reference Part #
1	MS16625-4081	Internal Retaining Ring	1	155-01200
2	MBA-01-10025	Spring Seat/Wiper Washer	1	095-01300
3	MS28775-113	O-Ring (Piston Head, Gland Static)	1	MS28775-113
4	MBA-01-10021	Lip Seal (Piston Rod, Dynamic)	1	MS28775-012
5	MBA-01-10022	End Gland	1	141-01200
6	MS28775-006	O-Ring (Piston Head Bypass)	1	MS28775-006
7	T5304-015	Snap Ring	1	155-04800
8	MS35333-40	Star Lock Washer	1	MS35333-40
9	AN316-4	Nut	1	AN316-4
10	AN960-616L	Flat Washer	1	AN960-616L

Caution: Piston Rod Lip Seal is made from Marsh Brothers proprietary material known as AeroLas™-Flex which is not compatible with phosphate ester hydraulic fluid, commercially known as Skydrol. Exposure to this fluid contamination will damage the seal.

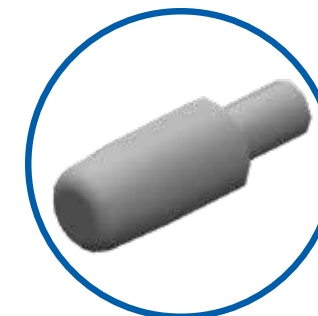

Seal Expansion Bullet
(included with kit)

See Installation Instructions for more information.

Cirrus Products Overview



Cleveland Brake Master Cylinder Upgrade/Repair Kit

FAA, TCCA and EASA Approved

Stop leaks around the piston rod with a better seal

Overview

You can rebuild your brake master cylinders because they're leaking or you can take a proactive approach and rebuild them before they leak, because in time, they will leak.

The biggest problem area is the piston rod to gland O-ring. The MBA kit replaces both the gland and changes the type of seal. The metal gland is replaced with a non-metallic gland of AeroTough® and the seal gives way to a V-ring polymer seal that won't leak no matter how cold the airplane gets sitting on the ramp.

All other parts in the kit are included to bring the cylinder up to better-than-new condition. The seal expansion bullet is just used during assembly to keep the piston rod threads from damaging the inner seal lip.

Just like struts that leak only when the airplane is very cold, the same can happen with the master cylinders and while the leak will likely stop once the cabin warms up, there's now a sticky mess around the brake pedal.

Benefits

- ✓ Avoid scratching the piston rod if dirt gets trapped between gland and rod.
- ✓ Don't buy a new cylinder; fix yours and make it better than new.
- ✓ Easy to install, typically completed in 1 hour.
- ✓ Fix it before it breaks.



Product Name	Product Num.	Price	Approved Models
Cirrus Design Corp.	M-00-1003-1	\$198.00 USD	See Following Page.

Approvals:

TCCA RDA No. C-RA22-016D

Approved Models:

Cirrus Design

SR20, SR22, SR22T

OEM Brake Master Cylinder P/N			
M-Kit	Aerostar Aircraft Corp.	Mooney	Cirrus Design Corp.
M-00-1003-1	980014-001 (MFG P/N: 10-24C)	10-24D	14269-001 (MFG P/N: 10-24C)

Item #	MBA Part #	Description	QTY	OEM Cross Reference Part #
1	MS16625-4081	Internal Retaining Ring	1	155-01200
2	MBA-01-10025	Spring Seat/Wiper Washer	1	095-01300
3	MS28775-113	O-Ring (Piston Head, Gland Static)	1	MS28775-113
4	MBA-01-10021	Lip Seal (Piston Rod, Dynamic)	1	MS28775-012
5	MBA-01-10022	End Gland	1	141-01200
6	MS28775-006	O-Ring (Piston Head Bypass)	1	MS28775-006
7	T5304-015	Snap Ring	1	155-04800
8	MS35333-40	Star Lock Washer	1	MS35333-40
9	AN316-4	Nut	1	AN316-4
10	AN960-616L	Flat Washer	1	AN960-616L

Caution: Piston Rod Lip Seal is made from Marsh Brothers proprietary material known as AeroLas™-Flex which is not compatible with phosphate ester hydraulic fluid, commercially known as Skydrol. Exposure to this fluid contamination will damage the seal.

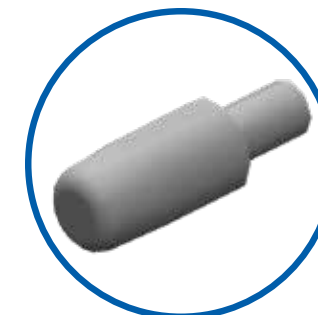

Seal Expansion Bullet
(included with kit)

See Installation Instructions for more information.

Polymer Spinner Washers

MBA spinner washers are designed to last for the life of the airplane

Overview

MBA spinner washers are CNC machined from a flexible polymer, not stamped from a sheet of Nylon.

The screw hole is sized so they need to be twisted on to the 10/32 screw. You'll find they'll outlast the screw. And, your mechanics won't lose them when they remove the screws during your annual inspection.

These washers are designed to assume the flat shape of the screw head on the outer surface and match the curvature of the spinner on the inside. They won't put any stress on the aluminum spinner trying to flatten it where it's supposed to be round.

Benefits

- ☑ We believe these washers will reduce or eliminate the tendency for spinners to crack.
- ☑ These washers can express your personality; like the red brake calipers on your car. If you're one who likes to show you value quality, pick yellow. If you prefer not to stand out in a crowd, pick clear. Grey is for conservatives who want to be sure they're still in place.



Grey

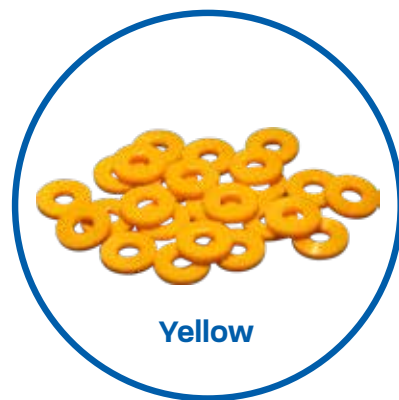

Yellow



Clear

Spinner Washers

Contents

MBA Part #	Description	Quantity	Price
M1020-5	Polymer Spinner Washers (Yellow)	5	\$19.00 USD
M1020-10	Polymer Spinner Washers (Yellow)	10	\$40.00 USD
M1020-25	Polymer Spinner Washers (Yellow)	25	\$108.00 USD
M1026-5	Polymer Spinner Washers (Grey)	5	\$19.00 USD
M1026-10	Polymer Spinner Washers (Grey)	10	\$40.00 USD
M1026-25	Polymer Spinner Washers (Grey)	25	\$108.00 USD
M1027-5	Polymer Spinner Washers (Clear)	5	\$19.00 USD
M1027-10	Polymer Spinner Washers (Clear)	10	\$40.00 USD
M1027-25	Polymer Spinner Washers (Clear)	25	\$108.00 USD

Prices subject to change without notice.



Cessna Products Overview



Shaw Aero
Aerotough®
Fuel Cap
Washers

AeroTough® GF Fuel Cap Washers

FAA, TCCA and EASA Approved

Avoid the hassle of difficult to open and close fuel caps.
An easier way.

Overview

Installing Marsh Brothers' Non-Metallic AeroTough® GF (Grease-Free) Fuel Cap Washers will ensure your fuel cap remains safe and functional, making opening and closing much easier. The washer which is CNC machined to exact shape is made from a polymer produced by Marsh Brothers' parent company and is not available commercially from any other source. It has extraordinary toughness and wear resistance. The friction is four times lower than steel on steel making the cap much easier to open and close.

Benefits

- ☑ Consistent open/close force required to operate the fuel cap locking tab.
- ☑ A smooth operation of the fuel cap locking tab.
- ☑ Long wear life.

"They Work! I did not expect a bit of polymer to be worth 90 bucks but I was wrong. It is hard to believe the improvement they bring to the gas cap. They are more than worth the price. You have to turn it to believe it."



Parker Aerospace / Shaw Aero AeroTough® Fuel Cap Washers

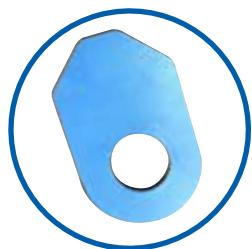

Gabb AeroTough® Fuel Cap Washers

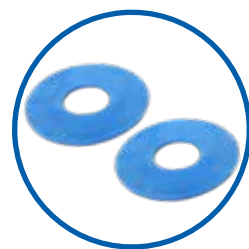

Parker Aerospace / Shaw Aero AeroTough® Fuel Cap Washers



Approved Models

Parts Design Approval No. PDA19-19

Fuel Cap			Aircraft Model Applicability	Package Quantity	Product Number	Price
Manufacturer	Model	P/N				
Gabb Special Products	N/A	37810-1	Textron Aviation: Baron Series, Bonanza Series, King Air 90 Series	Single	M-00-1001-1	\$79.00 USD
				Package of 2	M-00-1001-2	\$122.00 USD
				Package of 3	M-00-1001-3	\$162.00 USD
				Package of 4	M-00-1001-4	\$197.00 USD
	38339	King Air Series, 99 Series	Single	M-00-1002-1	\$79.00 USD	
			Package of 2	M-00-1002-2	\$122.00 USD	
			Package of 3	M-00-1002-3	\$162.00 USD	
			Package of 4	M-00-1002-4	\$197.00 USD	
Shaw Aero Device	416 Series	416-50 416-85	Textron Aviation: Baron Series, Bonanza Series	Single	M-00-1000-1	\$79.00 USD
				Package of 2	M-00-1000-2	\$122.00 USD
				Package of 3	M-00-1000-3	\$162.00 USD
				Package of 4	M-00-1000-4	\$197.00 USD
	431 Series	431-9	Textron Aviation: Baron Series, Bonanza Series, King Air 90 Series	Single	M-00-1000-1	\$79.00 USD
				Package of 2	M-00-1000-2	\$122.00 USD
				Package of 3	M-00-1000-3	\$162.00 USD
				Package of 4	M-00-1000-4	\$197.00 USD
	457 Series	457-113 457-115 457-116 457-370	Textron Aviation: Baron Series, Bonanza Series, King Air Series, 1900 Series, 99 Series	Single	M-00-1000-1	\$79.00 USD
				Package of 2	M-00-1000-2	\$122.00 USD
				Package of 3	M-00-1000-3	\$162.00 USD
				Package of 4	M-00-1000-4	\$197.00 USD
531 Series	531-001 531-033 531-046 531-035	Textron Aviation: Baron Series, Bonanza Series, Aerostar Aircraft Corporation: Aerostar Series	Single	M-00-1000-1	\$79.00 USD	
			Package of 2	M-00-1000-2	\$122.00 USD	
			Package of 3	M-00-1000-3	\$162.00 USD	
			Package of 4	M-00-1000-4	\$197.00 USD	
Parker Aerospace	416 Series	416-50	Textron Aviation: Baron Series, Bonanza Series	Single	M-00-1000-1	\$79.00 USD
				Package of 2	M-00-1000-2	\$122.00 USD
				Package of 3	M-00-1000-3	\$162.00 USD
				Package of 4	M-00-1000-4	\$197.00 USD
Parker/Shaw	N/A	39051-3	Textron Aviation: King Air Series	Single	M-04-1001-1	\$103.00 USD
				Package of 2	M-04-1001-2	\$168.00 USD
				Package of 3	M-04-1001-3	\$208.00 USD
				Package of 4	M-04-1001-4	\$243.00 USD

Prices subject to change without notice.

Polymer Spinner Washers

MBA spinner washers are designed to last for the life of the airplane

Overview

MBA spinner washers are CNC machined from a flexible polymer, not stamped from a sheet of Nylon.

The screw hole is sized so they need to be twisted on to the 10/32 screw. You'll find they'll outlast the screw. And, your mechanics won't lose them when they remove the screws during your annual inspection.

These washers are designed to assume the flat shape of the screw head on the outer surface and match the curvature of the spinner on the inside. They won't put any stress on the aluminum spinner trying to flatten it where it's supposed to be round.

Benefits

- ☑ We believe these washers will reduce or eliminate the tendency for spinners to crack.
- ☑ These washers can express your personality; like the red brake calipers on your car. If you're one who likes to show you value quality, pick yellow. If you prefer not to stand out in a crowd, pick clear. Grey is for conservatives who want to be sure they're still in place.



Grey

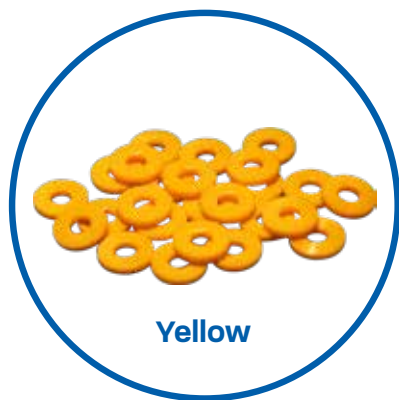

Yellow



Clear

Spinner Washers

Contents

MBA Part #	Description	Quantity	Price
M1020-5	Polymer Spinner Washers (Yellow)	5	\$19.00 USD
M1020-10	Polymer Spinner Washers (Yellow)	10	\$40.00 USD
M1020-25	Polymer Spinner Washers (Yellow)	25	\$108.00 USD
M1026-5	Polymer Spinner Washers (Grey)	5	\$19.00 USD
M1026-10	Polymer Spinner Washers (Grey)	10	\$40.00 USD
M1026-25	Polymer Spinner Washers (Grey)	25	\$108.00 USD
M1027-5	Polymer Spinner Washers (Clear)	5	\$19.00 USD
M1027-10	Polymer Spinner Washers (Clear)	10	\$40.00 USD
M1027-25	Polymer Spinner Washers (Clear)	25	\$108.00 USD

Prices subject to change without notice.



General Terms and Conditions of Sale

GOODS AND SERVICES SOLD BY MARSH BROTHERS AVIATION INC. ("SELLER") ARE EXPRESSLY SUBJECT TO THE TERMS AND CONDITIONS STATED BELOW. BUYERS ACCEPTANCE OF SHIPMENT OR PERFORMANCE AND/OR PAYMENT FOR GOODS OR SERVICES CONSTITUTES ACCEPTANCE OF SELLERS TERMS AND CONDITIONS.

1. PRICE

- a. Prices in effect at time of shipment of Goods shall prevail. All prices quoted by Seller are subject to correction or change without notice.
- b. Except as stated in Subsection 3(a) below, prices do not include freight, shipping, handling fees, duties, value-added or similar taxes. Where applicable such additional charges are billed as a separate item and paid by Buyer.

2. PAYMENT

- a. Seller accepts all major credit cards including Visa, Mastercard and American Express.
- b. Seller reserves the right to request additional forms of identification to confirm validity of the card holder.
- c. Seller accepts online payment systems including PayPal via our website only provided that the shipping address is a PayPal confirmed address. Orders paid for via PayPal cannot be combined with other payment methods. Orders paid for via PayPal cannot be modified after payment has been made. To modify orders paid for via PayPal, the order must be cancelled and a new order placed.
- d. Buyer agrees to hold Seller harmless for any costs incurred by Seller due to over limit or insufficient funds as assessed by Seller's credit card company or bank.

3. SHIPPING AND DELIVERY

- a. FREE SHIPPING. Seller offers free shipping on Qualifying Orders pursuant to subsection 3(b) below.
- b. QUALIFYING ORDERS. Orders greater than \$250 USD and with a destination address within Canada and the continental United States of America qualify for free shipping via FedEx Economy.
- c. INTERNATIONAL SHIPPING. The shipment of Goods to destinations outside of Canada and the continental United States of America are considered international shipments. All freight, shipping, duties, value-added or similar taxes and customs charges are the responsibility of the Buyer for international shipments. Buyer may specify shipping method for international orders. If Buyer does not specify shipping method, default shipping method is FedEx International Priority.
- d. FORCE MAJEURE. This Purchase is subject to and the Seller shall not be responsible or liable for delay, non-delivery and/or default directly or indirectly resulting from and/or contributed to, in whole or in part, by any foreign or domestic embargoes, seizures, acts of God, insurrections, war and/or continuance of war, or the adoption or enactment of any law, ordinance, regulation, ruling or order directly or indirectly interfering with or rendering more burdensome the production, delivery or payment hereunder, also lack of the usual means of transportation, fires, floods, explosions, strikes or other accidents or contingencies beyond the Seller's control, either of the foregoing nature or of any other kind, nature or description considered as "Force Majeure" in the Seller's or its suppliers' plants or elsewhere otherwise affecting transportation or production of the Goods or any parts used in or in connection with its production. In the event that any one or more deliveries hereunder is suspended or delayed by reason of any one or more of the occurrences or contingencies, as aforesaid, other than the Seller's own negligence, any and all deliveries so suspended or delayed shall be made after such disabilities have ceased to exist and nothing herein contained shall be construed as lessening in any event the full amount of the Goods herein purchased and sold, but only as deferring delivery and payment in the events and to the extent herein provided for.
- e. INSPECTION. Upon the arrival of the Goods at the Buyer's place of business or elsewhere as directed by the Buyer, the Buyer shall have the privilege of examining and inspecting the Goods before accepting delivery. Such inspection shall be made within 7 days after the arrival of such Goods at their destination.
- f. ACCEPTANCE. The Buyer agrees that if it retains the Goods in its possession or control for a period in excess of 7 days after delivery this shall automatically constitute and be deemed an irrevocable acceptance by the Buyer of the Goods and the delivery thereof, and a waiver by it of any and all claims that the Goods do not conform to this Purchase, unless the Buyer notifies the Seller in writing of any defect or non-conformity pursuant to Subsection 4(a), below. The Buyer agrees that if it so accepts the Goods under this Purchase, such acceptance satisfies all of the Seller's obligations and after acceptance the Buyer shall have no remedy against the Seller whatsoever, nor may the Buyer revoke its acceptance for any reason whatsoever.

4. RETURN POLICY

- a. NOTIFICATION. Pursuant to Subsection 3(e) above, if the Buyer discovers that any of the Goods delivered are defective in material or do not comply with the requirements of this Purchase, the Buyer shall notify the Seller of such discovery with sufficient detail, either for a return of such Goods or for a reduction in the agreed price of the Goods. In the event that the Buyer fails to make such claim within the time specified, the Buyer shall be liable for the payment of the full amount of the agreed price for the Goods so delivered. Notification shall be sent to the Seller's Customer Service.

- b. RETURN SHIPMENT. No returns shall be accepted after 30 days from the date of delivery. All return shipments require an RMA (Return Material Authorization) number, obtained from the Seller's Customer Service. Items that have been installed are not eligible for return. The return shipment, if any, is to be made by the Buyer to the Seller's business address. The Buyer shall be responsible for all return shipment costs inclusive of shipping, freight, duties and similar customs charges, unless otherwise agreed to.
- c. RESTOCKING FEE. Returns are subject to a restocking fee based on 15% of the selling price, or a minimum charge of \$50 USD. At the Seller's discretion, the restocking fee may be applied under the following conditions; returned Goods are shipped without an RMA number, or returned Goods are shipped without original documentation (i.e., Form One, C-of-C, shop report, etc.), or returned Goods are not shipped in the original Seller's packaging.
- d. RETURN EXCEPTIONS. Returns shall not be accepted if; Kits are missing parts, parts have been modified, altered or damaged in any way, or parts have been installed.

5. LIMITED WARRANTY AND LIABILITY

- a. BASIC TERMS. The Seller provides a limited Warranty on the Goods of its own manufacture sold by it to the Buyer thereof, against defects of material and workmanship.
- b. COVERAGE. This Limited Warranty covers the repair or replacement or the refund of the purchase price, as the Seller may elect, of any defective products regarding which, upon discovery of the defect, the Buyer has given immediate written notice pursuant to Subsection 4(a) above. The Seller does NOT warrant the merchantability of its product and does NOT make any warranty express or implied other than the warranty contained herein.
- c. THIRD PARTY PRODUCTS. Accessories, equipment and parts not manufactured by the Seller are warranted/guaranteed only to the extent and in the manner warranted and guaranteed to the Seller by the original manufacturer, and only to the extent the Seller is able to enforce such warranty or guarantee.
- d. LIMITED LIABILITY. The Seller's liability for any and all claims, damages, losses and injuries arising out of or relating to its performance or breach of any Sale of Goods and the manufacture, sale, delivery, re-sale, repair, or use of any Goods, shall NOT exceed the Buyer's purchase price of such Goods. The Buyer's remedy shall be at the Seller's option, the replacement or repair of the Goods. This shall be the Buyer's sole, exclusive and only remedy against the Seller. IN NO EVENT SHALL THE SELLER BE LIABLE FOR INCIDENTAL, SPECIAL OR CONSEQUENTIAL DAMAGES, INCLUDING BUT NOT LIMITED TO LOSS OF PROFITS, BUSINESS, GOODWILL INCURRING OF MACHINERY DOWNTIME, DESTRUCTION OR LOSS OF ANY CAPITAL GOODS, LIABILITY FOR PERSONAL INJURY, DEATH, PROPERTY DAMAGE AND ANY OTHER TYPE OF DAMAGES WHETHER SIMILAR TO OR DIFFERENT FROM THIS LISTING.
- e. EXCLUSIONS. The Seller shall, as to each defect, be relieved of all obligations and liability under this Limited Warranty if:
 - i. The Goods are operated with any accessory, equipment or part not specifically approved by the Seller and not manufactured by the Seller or to the Seller's design and specifications, unless the Buyer furnishes reasonable evidence that such installation was not a cause of the defect; provided, that this provision shall not apply to any accessory, equipment or part, the use of which does not affect the safety of the Goods.
 - ii. The Goods shall not be operated or maintained in accordance with the Seller's written instructions furnished under this Purchase, unless the Buyer furnishes reasonable evidence that such operation or maintenance was not a cause of the defect.
 - iii. The Goods shall not be operated under normal industry use, unless the Buyer furnishes reasonable evidence that such operation was not a cause of the defect.
 - iv. The Goods shall have been repaired, altered or modified without the Seller's approval or, if the Goods shall have been operated subsequent to involvement in an accident or breakdown, unless the Buyer furnishes reasonable evidence that such repair, alteration, modification, operation, accident or breakdown was not a cause of the defect; provided, however, that this limitation insofar as it relates to repairs, accidents and breakdowns, shall NOT be applicable to routine repairs or replacements or minor accidents or minor breakdowns which normally occur in the operation of a machine, if such repairs or replacements are made with suitable materials and according to standard practice and engineering.
 - v. The Buyer does not submit reasonable proof to the Seller that the defect is due to a material embraced within the Seller's Limited Warranty hereunder.
- f. EXPIRATION AND RELEASE. After the expiration of the Limited Warranty's period of time, as aforesaid, the Seller shall be released from all obligations and liabilities in respect of the warranty made by the Seller and contained in this Purchase or in any document given in order to carry out the transactions contemplated hereby.



Quality

Marsh Brothers Aviation's Quality Assurance Program is consistent with the ISO9001 standard and recognized by Transport Canada under our certifications as an Approved Manufacturer and as an AMO (Approved Maintenance Organization). The US Federal Aviation Administration recognizes a Canadian AMO as equivalent to Part 145 Repair Station status. We are dedicated to the continuous improvement of our Quality Assurance Program to ensure that we continue to meet the requirements of our customers to the fullest.

Applications Engineering

Marsh Brothers Aviation engineers work closely with customers to provide innovative product solutions and designs. We maintain in-house design, CAD/CAM and proprietary design tools to correctly size custom seals. Our decades of experience enable us to offer the right technical support over the entire product lifecycle.

Research & Development

Marsh Brothers Aviation maintains extensive in-house new product development laboratory capabilities as well as established relationships with academic institutions, offering Marsh Brothers Aviation a diverse and powerful R&D resource pool.

3225 Mainway, Burlington, ON L7M 1A6 Canada
1-800-263-6242 | info@marshbrothersaviation.com

www.MarshBrothersAviation.com



MBAPC 01/23
Printed in Canada